

# SSD1963

## *Product Preview*

**1215KB Embedded Display SRAM  
LCD Display Controller**

*Confidential*

This document contains information on a product under development. Solomon Systech reserves the right to change or discontinue this product without notice.

<http://www.solomon-systech.com>

**SSD1963**

Rev 0.20 | P 1/86

Dec 2008

Copyright © 2008 **Solomon Systech Limited**



**Appendix: IC Revision history of SSD1963 Specification**

<b>Version</b>	<b>Change Items</b>	<b>Effective Date</b>
0.10 21-Nov-08	1 <sup>st</sup> Release	24-Nov-08
0.10 08-Dec-08	Changed the set_pll_mnk to set_pll_mn in section 7.2 Change register name in section 8 Removed ABC Revised description for REG 0x00, 0x01, 0x0C, 0x0D, 0x0E, 0x10, 0x11, 0x21, 0x26, 0x28, 0x2A, 0x2B, 0x2C, 0x2E, 0x33, 0x34, 0x35, 0x36, 0x37, 0x3A, 0x3C, 0x3E, 0x44, 0x45, 0xA1, 0xB0, 0xB1, 0xB4, 0xB5, 0xB6, 0xB7, 0xB8, 0xB9, 0xBE, 0xBF, 0xD0, 0xD1, 0xD4, 0xE5. Added max VIH in Table 12-1 Added Table 9-1 Added Table 11-1 Revised Figure 9-19 Revised Figure 14-2 Revised Figure 13-4 Corrected typo for Table 7-2 Revised test condition for 12 and 13	10-Dec-08

**Confidential**

## CONTENTS

<b>1</b>	<b>GENERAL DESCRIPTION .....</b>	<b>8</b>
<b>2</b>	<b>FEATURES.....</b>	<b>8</b>
<b>3</b>	<b>ORDERING INFORMATION .....</b>	<b>8</b>
<b>4</b>	<b>BLOCK DIAGRAM .....</b>	<b>9</b>
<b>5</b>	<b>PIN ARRANGEMENT.....</b>	<b>10</b>
5.1	80 PIN TFBGA.....	10
5.2	128 PIN LQFP .....	11
<b>6</b>	<b>PIN DESCRIPTIONS .....</b>	<b>13</b>
<b>7</b>	<b>FUNCTIONAL BLOCK DESCRIPTIONS .....</b>	<b>16</b>
7.1	MCU INTERFACE.....	16
7.1.1	6800 Mode .....	16
7.1.2	8080 Mode .....	16
7.1.3	Register Pin Mapping .....	16
7.1.4	Pixel Data Format .....	16
7.1.5	Tearing Effect Signal (TE).....	17
7.2	SYSTEM CLOCK .....	17
7.3	FRAME BUFFER.....	18
7.4	SYSTEM CLOCK AND RESET MANAGER .....	18
7.5	LCD CONTROLLER.....	19
7.5.1	Display Format .....	19
7.5.2	General Purpose Input/Output (GPIO).....	19
<b>8</b>	<b>COMMAND TABLE.....</b>	<b>20</b>
<b>9</b>	<b>COMMAND DESCRIPTIONS.....</b>	<b>23</b>
9.1	NO OPERATION .....	23
9.2	SOFTWARE RESET .....	23
9.3	GET POWER MODE .....	23
9.4	GET ADDRESS MODE.....	24
9.5	GET PIXEL FORMAT .....	24
9.6	GET DISPLAY MODE.....	25
9.7	GET SIGNAL MODE.....	25
9.8	ENTER SLEEP MODE .....	26
9.9	EXIT SLEEP MODE .....	26
9.10	ENTER PARTIAL MODE .....	26
9.11	ENTER NORMAL MODE.....	27
9.12	EXIT INVERT MODE .....	27
9.13	ENTER INVERT MODE .....	27
9.14	SET GAMMA CURVE .....	28
9.15	SET DISPLAY OFF .....	28
9.16	SET DISPLAY ON .....	28
9.17	SET COLUMN ADDRESS .....	29
9.18	SET PAGE ADDRESS .....	29
9.19	WRITE MEMORY START .....	30
9.20	READ MEMORY START .....	31
9.21	SET PARTIAL AREA.....	31
9.22	SET SCROLL AREA.....	33
9.23	SET TEAR OFF .....	35
9.24	SET TEAR ON.....	35

9.25	SET ADDRESS MODE .....	35
9.26	SET SCROLL START .....	38
9.27	EXIT IDLE MODE .....	39
9.28	ENTER IDLE MODE .....	39
9.29	SET PIXEL FORMAT .....	40
9.30	WRITE MEMORY CONTINUE .....	40
9.31	READ MEMORY CONTINUE .....	41
9.32	SET TEAR SCANLINE.....	42
9.33	GET TEAR SCANLINE.....	42
9.34	READ DDB.....	43
9.35	SET LCD MODE.....	43
9.36	GET LCD MODE.....	45
9.37	SET HORIZONTAL PERIOD.....	46
9.38	GET HORIZONTAL PERIOD.....	47
9.39	SET VERTICAL PERIOD .....	48
9.40	GET VERTICAL PERIOD.....	48
9.41	SET GPIO CONFIGURATION.....	49
9.42	GET GPIO CONFIGURATION.....	50
9.43	SET GPIO VALUE .....	51
9.44	GET GPIO VALUE .....	51
9.45	SET POST PROC.....	52
9.46	GET POST PROC.....	52
9.47	SET PWM CONFIGURATION .....	53
9.48	GET PWM CONFIGURATION.....	54
9.49	SET LCD GEN0.....	55
9.50	GET LCD GEN0.....	56
9.51	SET LCD GEN1.....	57
9.52	GET LCD GEN1.....	58
9.53	SET LCD GEN2.....	59
9.54	GET LCD GEN2.....	60
9.55	SET LCD GEN3.....	61
9.56	GET LCD GEN3.....	62
9.57	SET GPIO0 ROP.....	63
9.58	GET GPIO0 ROP.....	63
9.59	SET GPIO1 ROP.....	64
9.60	GET GPIO1 ROP.....	65
9.61	SET GPIO2 ROP.....	65
9.62	GET GPIO2 ROP.....	66
9.63	SET GPIO3 ROP.....	67
9.64	GET GPIO3 ROP.....	67
9.65	SET DBC CONFIGURATION.....	68
9.66	GET DBC CONFIGURATION .....	69
9.67	SET DBC THRESHOLD .....	70
9.68	GET DBC THRESHOLD .....	71
9.69	SET PLL .....	71
9.70	SET PLL MN .....	72
9.71	GET PLL MN .....	73
9.72	GET PLL STATUS .....	73
9.73	SET DEEP SLEEP .....	73
9.74	SET LSHIFT FREQUENCY.....	74
9.75	GET LSHIFT FREQUENCY .....	74
9.76	SET PIXEL DATA INTERFACE.....	75
9.77	GET PIXEL DATA INTERFACE.....	75
<b>10</b>	<b>MAXIMUM RATINGS.....</b>	<b>76</b>
<b>11</b>	<b>RECOMMENDED OPERATING CONDITIONS .....</b>	<b>76</b>
11.1	POWER-UP SEQUENCE.....	76
<b>12</b>	<b>DC CHARACTERISTICS .....</b>	<b>77</b>

<b>13</b>	<b>AC CHARACTERISTICS</b> .....	<b>77</b>
13.1	CLOCK TIMING .....	77
13.2	MCU INTERFACE TIMING.....	78
13.2.1	6800 Mode .....	78
13.2.2	8080 Mode Write Cycle .....	79
13.3	LCD INTERFACE TIMING.....	80
13.4	8-BIT SERIAL INTERFACE.....	81
<b>14</b>	<b>APPLICATION EXAMPLE</b> .....	<b>82</b>
<b>15</b>	<b>PACKAGE INFORMATION</b> .....	<b>84</b>
15.1	PACKAGE MECHANICAL DRAWING FOR 80 PINS TFBGA .....	84
15.2	PACKAGE MECHANICAL DRAWING FOR 128 PINS LQFP.....	85

Confidential

## TABLES

TABLE 3-1: ORDERING INFORMATION .....	8
TABLE 5-1: TFBGA PIN ASSIGNMENT TABLE.....	10
TABLE 5-2 : LQFP PIN ASSIGNMENT TABLE .....	12
TABLE 6-1: MCU INTERFACE PIN MAPPING.....	13
TABLE 6-2: LCD INTERFACE PIN MAPPING.....	14
TABLE 6-3: CONTROL SIGNAL PIN MAPPING.....	14
TABLE 6-4: POWER PIN MAPPING.....	14
TABLE 6-5 : LCD INTERFACE PIN MAPPING .....	15
TABLE 7-1: PIXEL DATA FORMAT .....	16
TABLE 7-2: FRAME BUFFER SETTINGS REGRADING TO SET_ADDRESS_MODE COMMAND .....	18
TABLE 10-1: MAXIMUM RATINGS (VOLTAGE REFERENCED TO $V_{SS}$ ).....	76
TABLE 12-1 : DC CHARACTERISTICS .....	77
TABLE 13-1 : CLOCK INPUT REQUIREMENTS FOR CLK (PLL-BYPASS).....	77
TABLE 13-2 : CLOCK INPUT REQUIREMENTS FOR CLK (USING PLL).....	77
TABLE 13-3 : CLOCK INPUT REQUIREMENTS FOR CRYSTAL OSCILLATOR XTAL (USING PLL) .....	77
TABLE 13-4: 6800 MODE TIMING .....	78
TABLE 13-5: 8080 MODE TIMING .....	79

**Confidential**

## FIGURES

FIGURE 4-1: SSD1963 BLOCK DIAGRAM .....	9
FIGURE 5-1: PINOUT DIAGRAM –TFBGA (TOPVIEW).....	10
FIGURE 5-2 : PINOUT DIAGRAM – LQFP (TOPVIEW) .....	11
FIGURE 7-1: RELATIONSHIP BETWEEN TEARING EFFECT SIGNAL AND MCU MEMORY WRITING.....	17
FIGURE 7-2: CLOCK CONTROL DIAGRAM .....	18
FIGURE 7-3: STATE DIAGRAM OF SSD1963.....	19
FIGURE 9-1: EXIT INVERT MODE EXAMPLE.....	27
FIGURE 9-2: ENTER INVERT MODE EXAMPLE.....	28
FIGURE 9-3: SET COLUMN ADDRESS EXAMPLE .....	29
FIGURE 9-4: SET PAGE ADDRESS EXAMPLE .....	30
FIGURE 9-5: SET PARTIAL AREA WITH SET ADDRESS MODE 0x36 A[4] = 0.....	32
FIGURE 9-6: SET PARTIAL AREA WITH SET ADDRESS MODE 0x36 A[4] = 1.....	32
FIGURE 9-7: SET PARTIAL AREA WITH SET ADDRESS MODE 0x36 A[4] = 0.....	32
FIGURE 9-8: SET PARTIAL AREA WITH SET ADDRESS MODE 0x36 A[4] = 1.....	32
FIGURE 9-9: SET SCROLL AREA WITH SET ADDRESS MODE 0x36 A[4] = 0.....	34
FIGURE 9-10: SET SCROLL AREA WITH SET ADDRESS MODE 0x36 A[4] = 1.....	34
FIGURE 9-11: A[7] PAGE ADDRESS ORDER .....	36
FIGURE 9-12: A[6] COLUMN ADDRESS ORDER.....	36
FIGURE 9-13: A[5] PAGE / COLUMN ADDRESS ORDER .....	36
FIGURE 9-14: A[3] RGB ORDER.....	37
FIGURE 9-15: A[1] FLIP HORIZONTAL .....	37
FIGURE 9-16: A[0] FLIP VERTICAL.....	38
FIGURE 9-17: SET SCROLL START WITH SET ADDRESS MODE, 0x36 A[4] = 0.....	38
FIGURE 9-18: SET SCROLL START WITH SET ADDRESS MODE, 0x36 A[4] = 1.....	39
FIGURE 9-19: PWM SIGNAL .....	53
FIGURE 11-1: POWER-UP SEQUENCE .....	76
FIGURE 13-1: 6800 MODE TIMING DIAGRAM (USE CS# AS CLOCK).....	78
FIGURE 13-2: 6800 MODE TIMING DIAGRAM (USE E AS CLOCK).....	78
FIGURE 13-3: 8080 MODE TIMING DIAGRAM .....	79
FIGURE 13-4: GENERIC TFT PANEL TIMING.....	80
FIGURE 13-5: 8-BIT SERIAL INTERFACE TIMING .....	81
FIGURE 14-1 : APPLICATION CIRCUIT FOR SSD1963 (WITH DIRECT CLOCK INPUT).....	82
FIGURE 14-2 : APPLICATION CIRCUIT FOR SSD1963 (WITH CRYSTAL OSCILLATOR INPUT) .....	83

## 1 GENERAL DESCRIPTION

SSD1963 is a display controller of 1215K byte frame buffer to support up to 864 x 480 x 24bit graphics content. It also equips parallel MCU interfaces in different bus width to receive graphics data and command from MCU. Its display interface supports common RAM-less LCD driver of color depth up to 24 bit-per-pixel.

## 2 FEATURES

- Display feature
  - Built-in 1215K bytes frame buffer. Support up to 864 x 480 at 24bpp display
  - Support TFT 18/24-bit generic RGB and TTL interface panel
  - Support 8-bit RGB interface
  - Hardware rotation of 0, 90, 180, 270 degree
  - Hardware display mirroring
  - Hardware windowing
  - Programmable brightness, contrast and saturation control
  - Dynamic Backlight Control (DBC) via PWM signal
- MCU connectivity
  - 8/9/16/18/24-bit MCU interface
  - Tearing effect signal
- I/O Connectivity
  - 4 GPIO pins
- Built-in clock generator
- Deep sleep mode for power saving
- Core supply power ( $V_{DDPLL}$  and  $V_{DDD}$ ): 1.2V±0.1V
- I/O supply power ( $V_{DDIO}$ ): 1.65V to 3.6V
- LCD interface supply power ( $V_{DDLCD}$ ): 1.65V to 3.6V

## 3 ORDERING INFORMATION

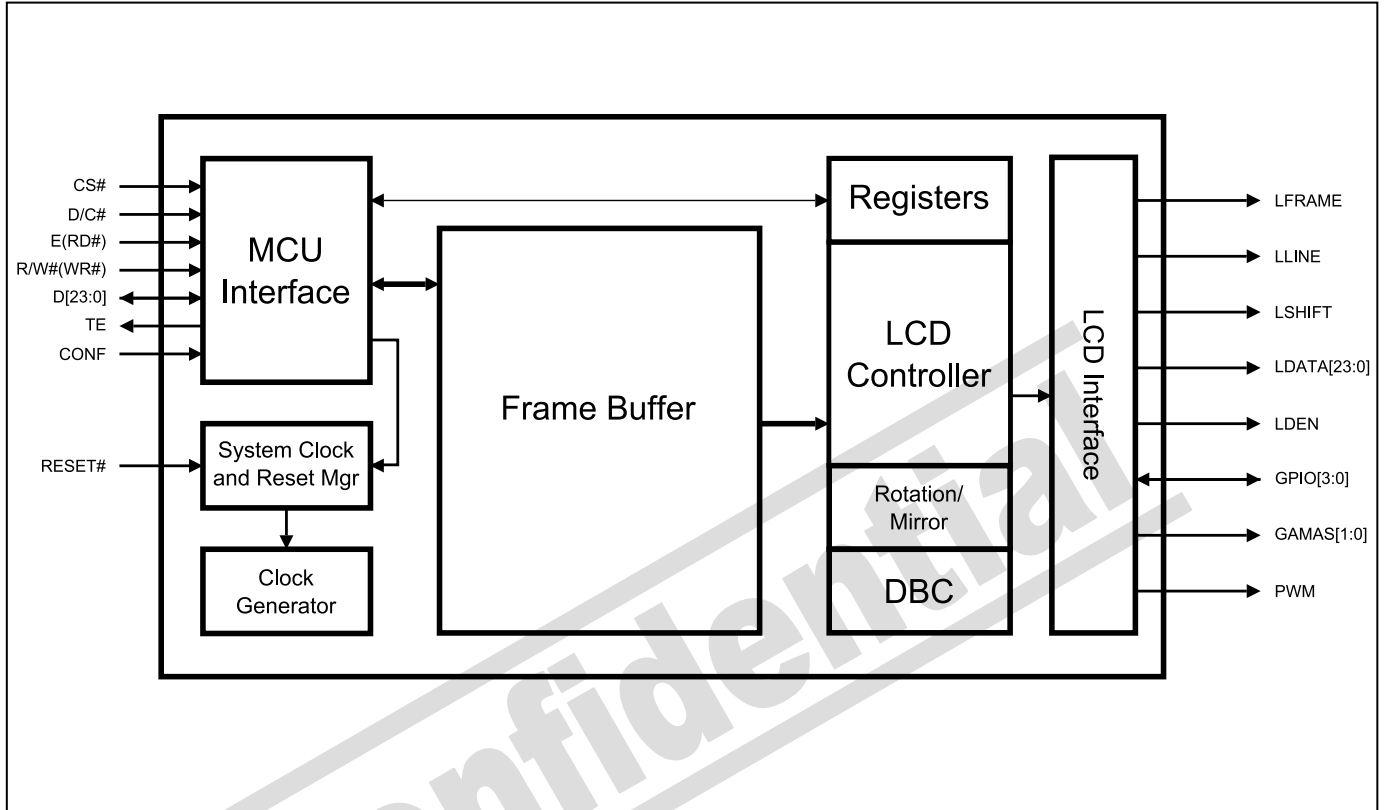
**Table 3-1: Ordering Information**

Ordering Part Number	Package Form
SSD1963G41	TFBGA-80
SSD1963QL9	LQFP-128



## 4 BLOCK DIAGRAM

Figure 4-1: SSD1963 Block Diagram



## 5 PIN ARRANGEMENT

### 5.1 80 pin TFBGA

Figure 5-1: Pinout Diagram –TFBGA (Topview)

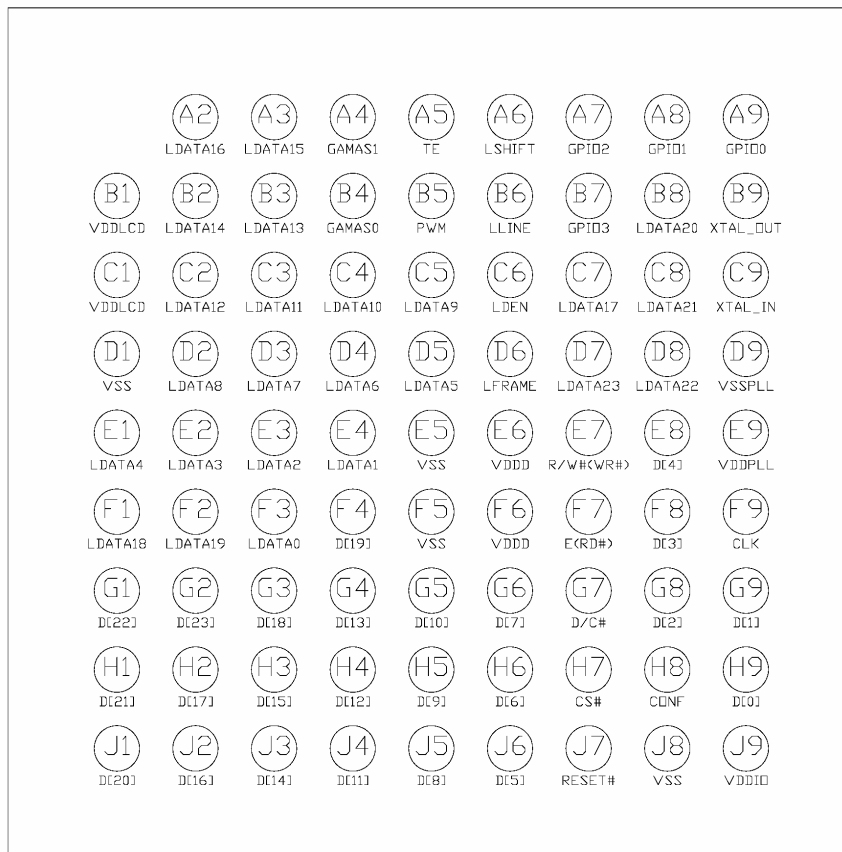
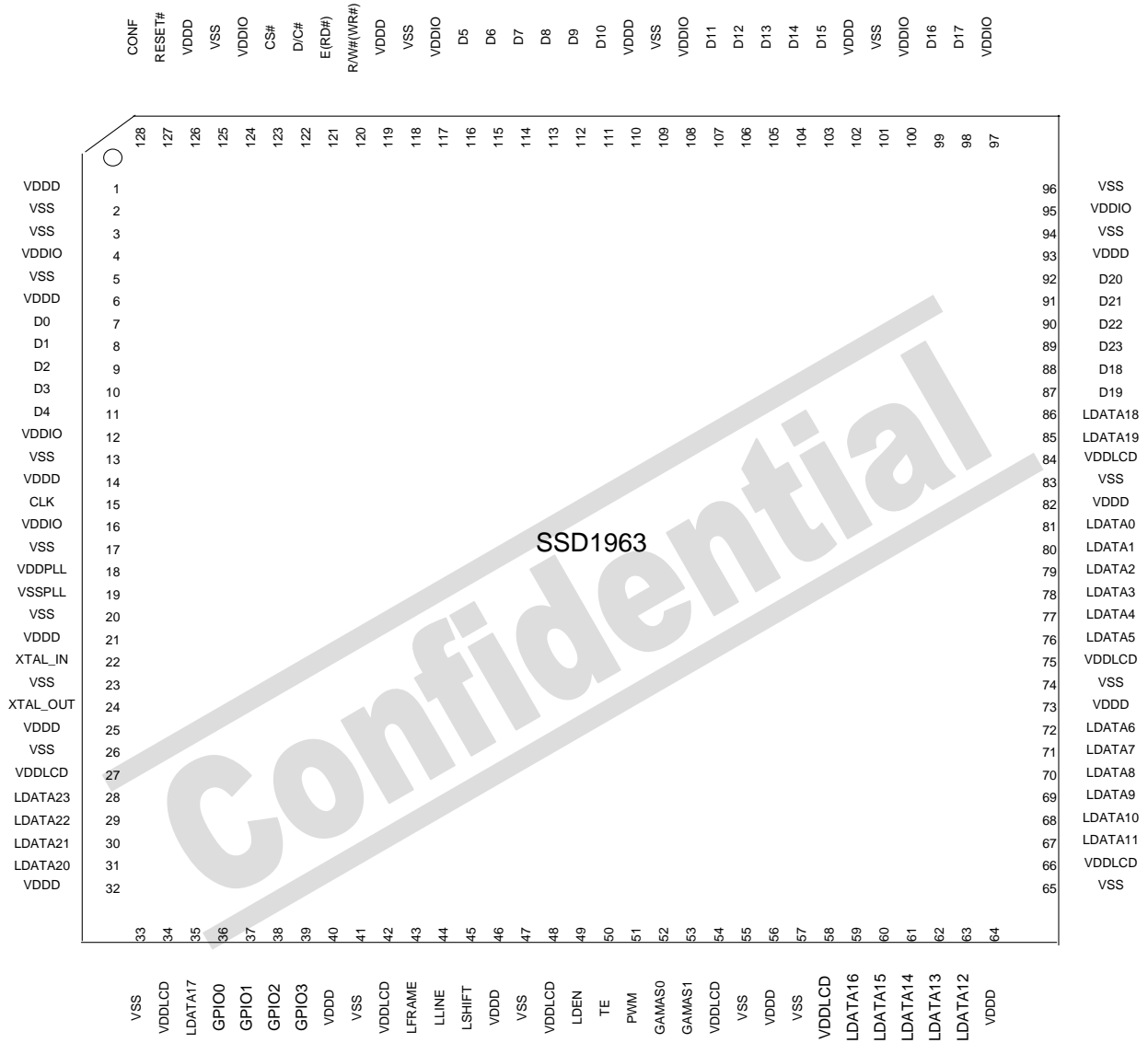


Table 5-1: TFBGA Pin Assignment Table

Pin #	Signal Name	Pin #	Signal Name	Pin #	Signal Name	Pin #	Signal Name	Pin #	Signal Name
A1	-	C1	VDDLCD	E1	LDATA4	G1	D[22]	J1	D[20]
A2	LDATA16	C2	LDATA12	E2	LDATA3	G2	D[23]	J2	D[16]
A3	LDATA15	C3	LDATA11	E3	LDATA2	G3	D[18]	J3	D[14]
A4	GAMAS1	C4	LDATA10	E4	LDATA1	G4	D[13]	J4	D[11]
A5	TE	C5	LDATA9	E5	VSS	G5	D[10]	J5	D[8]
A6	LSHIFT	C6	LDEN	E6	VDDD	G6	D[7]	J6	D[5]
A7	GPIO2	C7	LDATA17	E7	R/W# (WR#)	G7	D/C#	J7	RESET#
A8	GPIO1	C8	LDATA21	E8	D[4]	G8	D[2]	J8	VSS
A9	GPIO0	C9	XTAL_IN	E9	VDDPLL	G9	D[1]	J9	VDDIO
B1	VDDLCD	D1	VSS	F1	LDATA18	H1	D[21]		
B2	LDATA14	D2	LDATA8	F2	LDATA19	H2	D[17]		
B3	LDATA13	D3	LDATA7	F3	LDATA0	H3	D[15]		
B4	GAMAS0	D4	LDATA6	F4	D[19]	H4	D[12]		
B5	PWM	D5	LDATA5	F5	VSS	H5	D[9]		
B6	LLINE	D6	LFRAME	F6	VDDD	H6	D[6]		
B7	GPIO3	D7	LDATA23	F7	E(RD#)	H7	CS#		
B8	LDATA20	D8	LDATA22	F8	D[3]	H8	CONF		
B9	XTAL_OUT	D9	VSSPLL	F9	CLK	H9	D[0]		

## 5.2 128 pin LQFP

Figure 5-2 : Pinout Diagram – LQFP (Topview)



**Table 5-2 : LQFP Pin Assignment Table**

Pin #	Signal Name	Pin #	Signal Name	Pin #	Signal Name	Pin #	Signal Name
1	VDDD	33	VSS	65	VSS	97	VDDIO
2	VSS	34	VDDLCD	66	VDDLCD	98	D17
3	VSS	35	LDATA17	67	LDATA11	99	D16
4	VDDIO	36	GPIO0	68	LDATA10	100	VDDIO
5	VSS	37	GPIO1	69	LDATA9	101	VSS
6	VDDD	38	GPIO2	70	LDATA8	102	VDDD
7	D0	39	GPIO3	71	LDATA7	103	D15
8	D1	40	VDDD	72	LDATA6	104	D14
9	D2	41	VSS	73	VDDD	105	D13
10	D3	42	VDDLCD	74	VSS	106	D12
11	D4	43	LFRAME	75	VDDLCD	107	D11
12	VDDIO	44	LLINE	76	LDATA5	108	VDDIO
13	VSS	45	LSHIFT	77	LDATA4	109	VSS
14	VDDD	46	VDDD	78	LDATA3	110	VDDD
15	CLK	47	VSS	79	LDATA2	111	D10
16	VDDIO	48	VDDLCD	80	LDATA1	112	D9
17	VSS	49	LDEN	81	LDATA0	113	D8
18	VDDPLL	50	TE	82	VDDD	114	D7
19	VSSPLL	51	PWM	83	VSS	115	D6
20	VSS	52	GAMAS0	84	VDDLCD	116	D5
21	VDDD	53	GAMAS1	85	LDATA19	117	VDDIO
22	XTAL_IN	54	VDDLCD	86	LDATA18	118	VSS
23	VSS	55	VSS	87	D19	119	VDDD
24	XTAL_OUT	56	VDDD	88	D18	120	R/W#(WR#)
25	VDDD	57	VSS	89	D23	121	E(RD#)
26	VSS	58	VDDLCD	90	D22	122	D/C#
27	VDDLCD	59	LDATA16	91	D21	123	CS#
28	LDATA23	60	LDATA15	92	D20	124	VDDIO
29	LDATA22	61	LDATA14	93	VDDD	125	VSS
30	LDATA21	62	LDATA13	94	VSS	126	VDDD
31	LDATA20	63	LDATA12	95	VDDIO	127	RESET#
32	VDDD	64	VDDD	96	VSS	128	CONF

## 6 PIN DESCRIPTIONS

### Key:

- I = Input
- O =Output
- IO = Bi-directional (input/output)
- P = Power pin
- Hi-Z = High impedance

**Table 6-1: MCU Interface Pin Mapping**

Pin Name	Type	Reference Voltage Level	TFBGA Pin #	LQFP Pin #	Description
CLK	I	VDDIO	F9	15	TTL clock input. This pin should be tied to VSS if TTL clock input is not used
XTAL_IN	I	-	C9	22	Crystal oscillator input. This pin should be tied to VSS if not used
XTAL_OUT	O	-	B9	24	Crystal oscillator output. This pin should be floating if not used
CS#	I	VDDIO	H7	123	Chip select
D/C#	I	VDDIO	G7	122	Data/Command select
E(RD#)	I	VDDIO	F7	121	6800 mode: E (enable signal) 8080 mode: RD# (read strobe signal)
R/W#(WR#)	I	VDDIO	E7	120	6800 mode: R/W# 0: Write cycle 1: Read cycle 8080 mode: WR# (write strobe signal)
D[23:0]	IO	VDDIO	E8, F4, F8, G1, G2, G3, G4, G5, G6, G8, G9, H1, H2, H3, H4, H5, H6, H9, J1, J2,J3, J4, J5, J6	7, 8, 9, 10, 11, 87, 88, 89, 90, 91, 92, 98, 99, 103, 104, 105, 106, 107, 111, 112, 113, 114, 115, 116	Data bus. Pins not used should be floating
TE	O	VDDIO	A5	50	Tearing effect

**Table 6-2: LCD Interface Pin Mapping**

Pin Name	Type	Reference Voltage Level	TFBGA Pin #	LQFP Pin #	Description
LFRAME	O	VDDLCD	D6	43	Vertical sync (Frame pulse)
LLINE	O	VDDLCD	B6	44	Horizontal sync (Line pulse)
LSHIFT	O	VDDLCD	A6	45	Pixel clock (Pixel shift signal)
LDEN	O	VDDLCD	C6	49	Data valid
LDATA[23:0]	O	VDDLCD	A2, A3, B2, B3, B8, C2, C3, C4, C5, C7, C8, D2, D3, D4, D5, D7, D8, E1, E2, E3, E4, F1, F2, F3	28, 29, 30, 31, 35, 59, 60, 61, 62, 63, 67, 68, 69, 70, 71, 72, 76, 77, 78, 79, 80, 81, 85, 86	RGB data
GPIO[3:0]	IO	VDDLCD	A7, A8, A9, B7	36, 37, 38, 39	These pins can be configured for display miscellaneous signals or as general purpose I/O. Default as input
GAMAS [1:0]	O	VDDLCD	A4, B4	52, 53	Gamma selection for panel
PWM	O	VDDLCD	B5	51	PWM output for backlight driver

**Table 6-3: Control Signal Pin Mapping**

Pin Name	Type	Reference Voltage Level	TFBGA Pin #	LQFP Pin #	Description
RESET#	I	VDDIO	J7	127	Master synchronize reset
CONF	I	VDDIO	H8	128	MCU interface configuration 0: 6800 Interface 1: 8080 Interface

**Table 6-4: Power Pin Mapping**

Pin Name	Type	TFBGA Pin #	LQFP Pin #	Description
VDDD	P	E6, F6	1, 6, 14, 21, 25, 32, 40, 46, 56, 64, 73, 82, 93, 102, 110, 119, 126	Power supply for internal digital circuit
VDDLCD	P	B1, C1	27, 34, 42, 48, 54, 58, 66, 75, 84	Power supply for LCD interface related pads
VDDPLL	P	E9	18	Power supply for internal analog circuit and analog I/O pads
VDDIO	P	J9	4, 12, 16, 95, 97, 100, 108, 117, 124	Power supply for digital I/O pads
VSS	P	D1, E5, F5, J8	2, 3, 5, 13, 17, 20, 23, 26, 33, 41, 47, 55, 57, 65, 74, 83, 94, 96, 101, 109, 118, 125	Ground for internal digital circuit
VSSPLL	P	D9	19	Ground for internal analog circuit and analog I/O pads

**Table 6-5 : LCD Interface Pin Mapping**

Pin Names	24-bit	18-bit	8-bit serial
LFRAME		FRAME	
LLINE		LINE	
LSHIFT		SHIFT	
LDEN		DEN	
LDATA23	R7	Drive 0	Drive 0
LDATA22	R6	Drive 0	Drive 0
LDATA21	R5	Drive 0	Drive 0
LDATA20	R4	Drive 0	Drive 0
LDATA19	R3	Drive 0	Drive 0
LDATA18	R2	Drive 0	Drive 0
LDATA17	R1	R5	Drive 0
LDATA16	R0	R4	Drive 0
LDATA15	G7	R3	Drive 0
LDATA14	G6	R2	Drive 0
LDATA13	G5	R1	Drive 0
LDATA12	G4	R0	Drive 0
LDATA11	G3	G5	Drive 0
LDATA10	G2	G4	Drive 0
LDATA9	G1	G3	Drive 0
LDATA8	G0	G2	Drive 0
LDATA7	B7	G1	D7
LDATA6	B6	G0	D6
LDATA5	B5	B5	D5
LDATA4	B4	B4	D4
LDATA3	B3	B3	D3
LDATA2	B2	B2	D2
LDATA1	B1	B1	D1
LDATA0	B0	B0	D0

**Note**

- (1) These pin mappings use signal names commonly used for each panel type, however signal names may differ between panel manufacturers.

## 7 FUNCTIONAL BLOCK DESCRIPTIONS

### 7.1 MCU Interface

The MCU interface connects the MCU and SSD1963 graphics controller. The MCU interface can be configured as 6800 mode and 8080 mode by the CONF pin. By pulling the CONF pin to VSSIO, the MCU interface will be configured as 6800 mode interface. If the CONF pin is connected to VDDIO, the MCU interface will be configure in 8080 mode.

#### 7.1.1 6800 Mode

The 6800 mode MCU interface consist of CS#, D/C#, E, R/W#, D[23:0], and TE signals (Please refer to Table 6-1 for pin multiplexed with 8080 mode). This interface supports both fixed E and clock E scheme to define a read/write cycle. If the E signal is kept high and used as enable signal, the CS# signal acts as a bus clock, the data or command will be latched into the system at the rising edge of CS#. If the user wants to use the E pin as the clock pin, the CS# pin then need to be fixed to logic 0 to select the chip. Then the falling edge of the E signal will latch the data or command. For details, please refer to the timing diagram in chapter 13.2.1.

#### 7.1.2 8080 Mode

The 8080 mode MCU interface consist of CS#, D/C#, RD#, WR#, D[23:0] and TE signals (Please refer to Table 6-1 for pin multiplexed with 6800 mode). This interface use WR# to define a write cycle and RD# for read cycle. If the WR# goes low when the CS# signal is low, the data or command will be latched into the system at the rising edge of WR#. Similarly, the read cycle will start when RD# goes low and end at the rising edge of RD#. The detailed timing will show in the chapter 13.2.2.

#### 7.1.3 Register Pin Mapping

When user access the registers via the parallel MCU interface, only D[7:0] will be used regardless the width of the pixel data is. Therefore, D[23:8] will only be used to address the display data only. This provided the possibility that the pixel data format as shown in Table 7-1 can be configured by register 0xF0.

#### 7.1.4 Pixel Data Format

Both 6800 and 8080 support 8-bit, 9-bit, 16-bit, 18-bit and 24-bit data bus. Depending on the width of the data bus, the display data are packed into the data bus in different ways.

Table 7-1: Pixel Data Format

Interface	Cycle	D[23]	D[22]	D[21]	D[20]	D[19]	D[18]	D[17]	D[16]	D[15]	D[14]	D[13]	D[12]	D[11]	D[10]	D[9]	D[8]	D[7]	D[6]	D[5]	D[4]	D[3]	D[2]	D[1]	D[0]		
24 bits	1 <sup>st</sup>	R7	R6	R5	R4	R3	R2	R1	R0	G7	G6	G5	G4	G3	G2	G1	G0	B7	B6	B5	B4	B3	B2	B1	B0		
18 bits	1 <sup>st</sup>							R5	R4	R3	R2	R1	R0	G5	G4	G3	G2	G1	G0	B5	B4	B3	B2	B1	B0		
16 bits (565 format)	1 <sup>st</sup>									R5	R4	R3	R2	R1	G5	G4	G3	G2	G1	G0	B5	B4	B3	B2	B1		
16 bits	1 <sup>st</sup>									R5	R4	R3	R2	R1	R0	X	X	G5	G4	G3	G2	G1	G0	X	X		
	2 <sup>nd</sup>																	X	X	R5	R4	R3	R2	R1	R0	X	X
	3 <sup>rd</sup>																	X	X	B5	B4	B3	B2	B1	B0	X	X
9 bits	1 <sup>st</sup>																										
	2 <sup>nd</sup>																										
8 bits	1 <sup>st</sup>																										
	2 <sup>nd</sup>																										
	3 <sup>rd</sup>																										

X: Don't Care

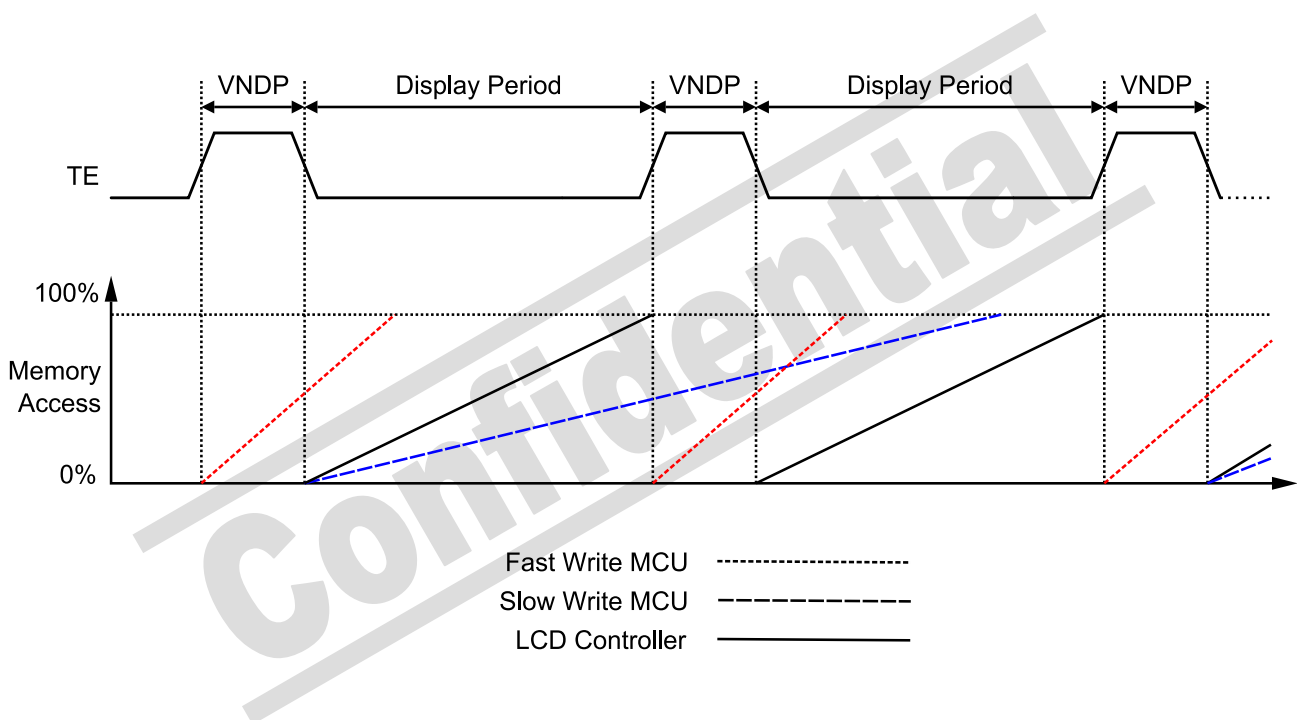


### 7.1.5 Tearing Effect Signal (TE)

The Tearing Effect Signal (TE) is a feedback signal from the LCD Controller to MCU. This signal reveals the display status of LCD controller. In the non-display period, the TE signal will go high. Therefore, this signal enables the MCU to send data by observing the non-display period to avoid tearing.

Figure 7-1 shows how the TE signal helps to avoid tearing. If the MCU writing speed is slower than the display speed, the display data should be updated after the LCD controller start to scan the frame buffer. Then the LCD controller will always display the old memory content until the next frame. However, if the MCU is faster than the LCD controller, it should start updating the display content in the vertical non-display period (VNDP) to enable the LCD controller will always get the newly updated data.

Figure 7-1: Relationship between Tearing Effect Signal and MCU Memory Writing



In SSD1963 graphics controller, users can configure the TE signal to reflect the vertical non-display period only or reflect both vertical and horizontal non-display period. With the additional horizontal non-display period information, the MCU can control the refresh action in more accurately by counting the horizontal line scanned by the LCD controller. Usually, a fast MCU will not need horizontal non-display period. But a slow MCU will need it to ensure the frame buffer update process always lags behind the LCD controller.

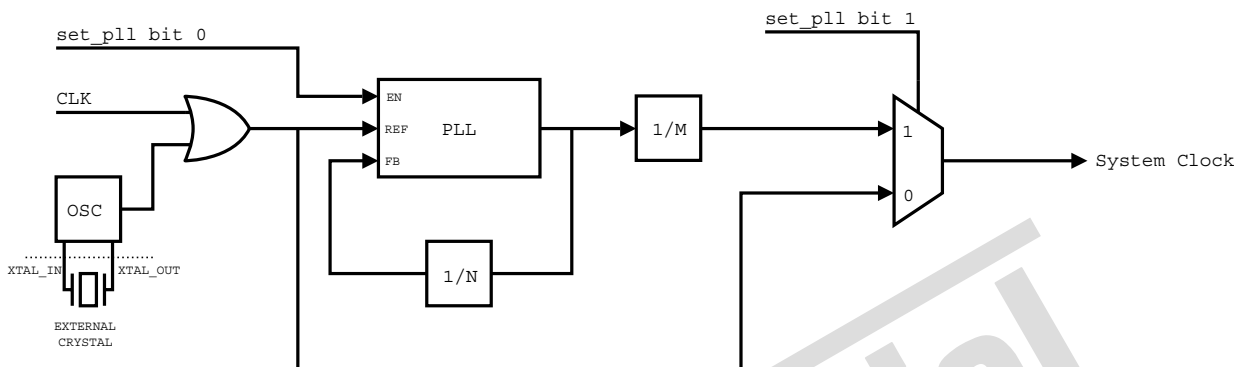
The TE signal is not generated by the MCU interface but the LCD controller. The MCU interface only route the signal to the external pad.

### 7.2 System Clock

The system clock of SSD1963 is generated by the built-in PLL. The reference clock of the PLL can come from either the CLK pin or the internal crystal oscillator. Since the CLK pin and the output of the oscillator was connected to PLL with an "OR" gate, the unused clock must be tied to VSS.

Before the PLL output is configured as the system clock by the bit 1 of “set\_pll” command, the system will be clocked by the reference clock. This enables the user to send the “set\_pll\_mn” command to the PLL for frequency configuration. When the PLL frequency is configured and the PLL was enabled with the bit 0 of “set\_pll” command, the user should still wait for 100ms for the PLL to lock. Then the PLL is ready and can be configured as system clock with the bit 1 of “set\_pll” command.

**Figure 7-2: Clock Control Diagram**



### 7.3 Frame Buffer

There are 1215K bytes built-in SRAM inside SSD1963 to use as frame buffer. When the frame buffer is written or read, the “address counter” will automatically increase by one or decrease by one depends on the frame buffer settings.

**Table 7-2: Frame Buffer Settings regarding to set\_address\_mode command 0x36**

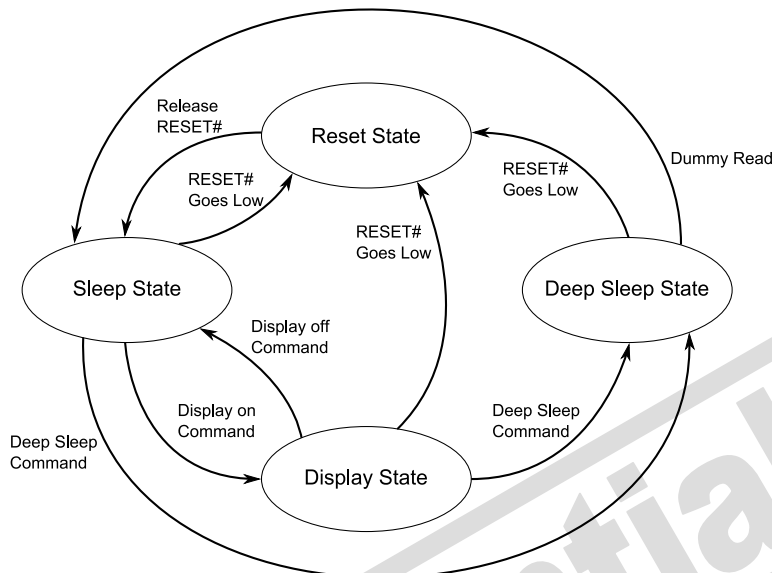
	Option 1 Horizontal: Increment Vertical: Increment B6 = 0; B7 = 0	Option 2 Horizontal: Increment Vertical: Decrement B6 = 0; B7 = 1	Option 3 Horizontal: Decrement Vertical: Increment B6 = 1; B7 = 0	Option 4 Horizontal: Decrement Vertical: Decrement B6 = 1; B7 = 1
Horizontal Frame Buffer Mode B5 = 0	00000h  5DC00h	00000h  5DC00h	00000h  5DC00h	00000h  5DC00h
Vertical Frame Buffer Mode B5 = 1	00000h  5DC00h	00000h  5DC00h	00000h  5DC00h	00000h  5DC00h

### 7.4 System Clock and Reset Manager

The “System Clock and Reset Manager” distributes the reset signal and clock signal to the entire system. It controls the Clock Generator and contains clock gating circuitry to turn on and off the clock of each functional module. Also, it divides the root clock from Clock Generator to operation clocks for different

module. The System Clock and Reset Manager also manage the reset signals to ensure all the module are reset to appropriate status when the system are in reset state, deep sleep state, sleep state and display state. Figure 7-3 shows a state diagram of four operation states of SSD1963.

**Figure 7-3: State Diagram of SSD1963**



Reset State:	Deep Sleep State:	Sleep State:	Display State:
Clock Generator Stop	Clock Generator Stop	Clock Generator On	Clock Generator On
Unable to Receive Command	Unable to Receive Command	Able to Receive Command	Able to Receive Command
Unable to Update Frame Buffer	Unable to Update Frame Buffer	Able to Update Frame Buffer	Able to Update Frame Buffer
Display Off	Display Off	Display Off	Display On
All Settings Reset	All Settings Retain	All Settings Retain	All Settings Retain

## 7.5 LCD Controller

### 7.5.1 Display Format

The LCD controller reads the frame buffer and generates display signals according to the selected display panel format. SSD1963 supports common RAM-less TFT driver using generic RGB data format or TTL format.

### 7.5.2 General Purpose Input/Output (GPIO)

The GPIO pins can operate in 2 modes, GPIO mode and miscellaneous display signal mode. When the pins are configured as GPIOs, these pins can be controlled directly by MCU. Therefore, user can use these pins to emulate other interface such as SPI or I2C. If these pins are configured as display signals, they will toggle with display periodically according to the signal settings. They can be set to toggle once a frame, once a line or in arbitrary period. Therefore they can be configured as some common signal needed for different panels such as STH or LP.

## 8 COMMAND TABLE

Hex Code	Command	Description
0x 00	nop	No operation
0x 01	soft_reset	Software Reset
0x 0A	get_power_mode	Get the current power mode
0x 0B	get_address_mode	Get the frame memory to the display panel read order
0x 0C	get_pixel_format	Get the current pixel format
0x 0D	get_display_mode	The display module returns the Display Signal Mode.
0x 0E	get_signal_mode	Get the current display mode from the peripheral
0x 0F	Reserved	Reserved
0x 10	enter_sleep_mode	Turn off the panel. This command will pull low the GPIO0. If GPIO0 is configured as normal GPIO or LCD miscellaneous signal with command set_gpio_conf, this command will be ignored.
0x 11	exit_sleep_mode	Turn on the panel. This command will pull high the GPIO0. If GPIO0 is configured as normal GPIO or LCD miscellaneous signal with command set_gpio_conf, this command will be ignored.
0x 12	enter_partial_mode	Part of the display area is used for image display.
0x 13	enter_normal_mode	The whole display area is used for image display.
0x 20	exit_invert_mode	Displayed image colors are not inverted.
0x 21	enter_invert_mode	Displayed image colors are inverted.
0x 26	set_gamma_curve	Selects the gamma curve used by the display device.
0x 28	set_display_off	Blanks the display device
0x 29	set_display_on	Show the image on the display device
0x 2A	set_column_address	Set the column extent
0x 2B	set_page_address	Set the page extent
0x 2C	write_memory_start	Transfer image information from the host processor interface to the peripheral starting at the location provided by set_column_address and set_page_address
0x 2E	read_memory_start	Transfer image data from the peripheral to the host processor interface starting at the location provided by set_column_address and set_page_address
0x 30	set_partial_area	Defines the partial display area on the display device
0x 33	set_scroll_area	Defines the vertical scrolling and fixed area on display area
0x 34	set_tear_off	Synchronization information is not sent from the display module to the host processor
0x 35	set_tear_on	Synchronization information is sent from the display module to the host processor at the start of VFP
0x 36	set_address_mode	Set the read order from frame buffer to the display panel
0x 37	set_scroll_start	Defines the vertical scrolling starting point
0x 38	exit_idle_mode	Full color depth is used for the display panel
0x 39	enter_idle_mode	Reduce color depth is used on the display panel.
0x 3A	set_pixel_format	Defines how many bits per pixel are used in the interface
0x 3C	write_memory_continue	Transfer image information from the host processor interface to the peripheral from the last written location
0x 3E	read_memory_continue	Read image data from the peripheral continuing after the last read_memory_continue or read_memory_start
0x 44	set_tear_scanline	Synchronization information is sent from the display module to the host processor when the display device refresh reaches the provided scanline

Hex Code	Command	Description
0x 45	get_scanline	Get the current scan line
0x A1	read_ddb	Read the DDB from the provided location
0x A8	Reserved	Reserved
0x B0	set_lcd_mode_	Set the LCD panel mode (RGB TFT or TTL)
0x B1	get_lcd_mode	Get the current LCD panel mode, pad strength and resolution
0x B4	set_hori_period	Set front porch
0x B5	get_hori_period	Get current front porch settings
0x B6	set_vert_period	Set the vertical blanking interval between last scan line and next LFRAME pulse
0x B7	get_vert_period	Set the vertical blanking interval between last scan line and next LFRAME pulse
0x B8	set_gpio_conf	Set the GPIO configuration. If the GPIO is not used for LCD, set the direction. Otherwise, they are toggled with LCD signals.
0x B9	get_gpio_conf	Get the current GPIO configuration
0x BA	set_gpio_value	Set GPIO value for GPIO configured as output
0x BB	get_gpio_status	Read current GPIO status. If the individual GPIO was configured as input, the value is the status of the corresponding pin. Otherwise, it is the programmed value.
0x BC	set_post_proc	Set the image post processor
0x BD	get_post_proc	Set the image post processor
0x BE	set_pwm_conf	Set the image post processor
0x BF	get_pwm_conf	Set the image post processor
0x C0	set_lcd_gen0	Set the rise, fall, period and toggling properties of LCD signal generator 0
0x C1	get_lcd_gen0	Get the current settings of LCD signal generator 0
0x C2	set_lcd_gen1	Set the rise, fall, period and toggling properties of LCD signal generator 1
0x C3	get_lcd_gen1	Get the current settings of LCD signal generator 1
0x C4	set_lcd_gen2	Set the rise, fall, period and toggling properties of LCD signal generator 2
0x C5	get_lcd_gen2	Get the current settings of LCD signal generator 2
0x C6	set_lcd_gen3	Set the rise, fall, period and toggling properties of LCD signal generator 3
0x C7	get_lcd_gen3	Get the current settings of LCD signal generator 3
0x C8	set_gpio0_rop	Set the GPIO0 with respect to the LCD signal generators using ROP3 operation. No effect if the GPIO0 is configured as general GPIO.
0x C9	get_gpio0_rop	Get the GPIO0 properties with respect to the LCD signal generators.
0x CA	set_gpio1_rop	Set the GPIO1 with respect to the LCD signal generators using ROP3 operation. No effect if the GPIO1 is configured as general GPIO.
0x CB	get_gpio1_rop	Get the GPIO1 properties with respect to the LCD signal generators.
0x CC	set_gpio2_rop	Set the GPIO2 with respect to the LCD signal generators using ROP3 operation. No effect if the GPIO2 is configured as general GPIO.
0x CD	get_gpio2_rop	Get the GPIO2 properties with respect to the LCD signal generators.

Hex Code	Command	Description
0x CE	set_gpio3_rop	Set the GPIO3 with respect to the LCD signal generators using ROP3 operation. No effect if the GPIO3 is configured as general GPIO.
0x CF	get_gpio3_rop	Get the GPIO3 properties with respect to the LCD signal generators.
0x D0	set_dbc_conf	Set the dynamic back light configuration
0x D1	get_dbc_conf	Get the current dynamic back light configuration
0x D4	set_dbc_th	Set the threshold for each level of power saving
0x D5	get_dbc_th	Get the threshold for each level of power saving
0x E0	set_pll	Start the PLL. Before the start, the system was operated with the crystal oscillator or clock input
0x E2	set_pll_mn	Set the PLL
0x E3	get_pll_mn	Get the PLL settings
0x E4	get_pll_status	Get the current PLL status
0x E5	set_deep_sleep	Set deep sleep mode
0x E6	set_lshift_freq	Set the LSHIFT (pixel clock) frequency
0x E7	get_lshift_freq	Get current LSHIFT (pixel clock) frequency setting
0x E8	Reserved	Reserved
0x E9	Reserved	Reserved
0x F0	set_pixel_data_interface	Set the pixel data format of the parallel host processor interface
0x F1	get_pixel_data_interface	Get the current pixel data format settings
0x FF	Reserved	Reserved

## 9 COMMAND DESCRIPTIONS

### 9.1 No operation

**Command** 00h  
**Parameters** None

	D/C	D7	D6	D5	D4	D3	D2	D1	D0	Hex
Command	0	0	0	0	0	0	0	0	0	00

#### Description

No operation. It can be used to terminate the frame buffer write or read for Write Memory Continue, 0x3C and Read Memory Continue, 0x3E.

### 9.2 Software Reset

**Command** 01h  
**Parameters** None

	D/C	D7	D6	D5	D4	D3	D2	D1	D0	Hex
Command	0	0	0	0	0	0	0	0	1	01

#### Description

The display module performs a software reset. Only the configuration register will be reset.

Note :

The host processor must wait 5ms before sending any new commands to a SSD1963 following this command.

The host processor must wait 120ms before sending an Exit Sleep Mode, 0x11.

### 9.3 Get Power Mode

**Command** 0Ah  
**Parameters** 1

	D/C	D7	D6	D5	D4	D3	D2	D1	D0	Hex
Command	0	0	0	0	0	1	0	1	0	0A
Parameter 1	1	0	A <sub>6</sub>	A <sub>5</sub>	A <sub>4</sub>	A <sub>3</sub>	A <sub>2</sub>	0	0	xx

#### Description

Get the current power mode

A[6] : Idle mode on/off (POR = 0)

- 0 Idle mode off
- 1 Idle mode on

A[5] : Partial mode on/off (POR = 0)

- 0 Partial mode off
- 1 Partial mode on

A[4] : Sleep mode on/off (POR = 0)

- 0 Sleep mode on
- 1 Sleep mode off

A[3] : Display normal mode on/off (POR = 1)

0 Display normal mode off

1 Display normal mode on

A[2] : Display on/off (POR = 0)

0 Display is off

1 Display is on

## 9.4 Get Address Mode

**Command** 0Bh

**Parameters** 1

	D/C	D7	D6	D5	D4	D3	D2	D1	D0	Hex
Command	0	0	0	0	0	1	0	1	1	0B
Parameter 1	1	A <sub>7</sub>	A <sub>6</sub>	A <sub>5</sub>	A <sub>4</sub>	A <sub>3</sub>	A <sub>2</sub>	0	0	xx

### Description

Get the frame buffer to the display panel read order

A[7] : Page address order (POR = 0)

0 Top to bottom

1 Bottom to top

A[6] : Column address order (POR = 0)

0 Left to right

1 Right to left

A[5] : Page / Column order (POR = 0)

0 Normal mode

1 Reverse mode

A[4] : Line address order (POR = 0)

0 LCD refresh top to bottom

1 LCD refresh bottom to top

A[3] : RGB / BGR order (POR = 0)

0 RGB

1 BGR

A[2] : Display data latch data (POR = 0)

0 LCD refresh left to right

1 LCD refresh right to left

## 9.5 Get Pixel Format

**Command** 0Ch

**Parameters** 1

	D/C	D7	D6	D5	D4	D3	D2	D1	D0	Hex
Command	0	0	0	0	0	1	1	0	0	0C
Parameter 1	1	0	A <sub>6</sub>	A <sub>5</sub>	A <sub>4</sub>	0	0	0	0	xx

### Description

Get the current pixel format for the RGB image data.



A[6:4] : Display pixel format (POR = 000)

000	Reserved
001	3-bit/pixel
010	8-bit/pixel
011	12-bit/pixel
100	Reserved
101	16-bit/pixel
110	18-bit/pixel
111	24-bit/pixel

## 9.6 Get Display mode

**Command** 0Dh  
**Parameters** 1

	D/C	D7	D6	D5	D4	D3	D2	D1	D0	Hex
Command	0	0	0	0	0	1	1	0	1	0D
Parameter 1	1	A <sub>7</sub>	0	A <sub>5</sub>	0	0	A <sub>2</sub>	A <sub>1</sub>	A <sub>0</sub>	xx

### Description

The display module returns the Display Image Mode status.

A[7] : Vertical scrolling status (POR = 0)

0	Vertical scrolling is off
1	Vertical scrolling is on

A[5] : Inversion on/off (POR = 0)

0	Inversion is off
1	Inversion is on

A[2:0] : Gamma curve selection (POR = 011)

000	Gamma curve 0
001	Gamma curve 1
010	Gamma curve 2
011	Gamma curve 3
100	Reserved
101	Reserved
110	Reserved
111	Reserved

## 9.7 Get Signal Mode

**Command** 0Eh  
**Parameters** 1

	D/C	D7	D6	D5	D4	D3	D2	D1	D0	Hex
Command	0	0	0	0	0	1	1	1	0	0E
Parameter 1	1	A <sub>7</sub>	0	0	0	0	0	0	0	xx

### Description

Get the current display signal mode from the peripheral

A[7] : Tearing effect line mode (POR = 0)

0	Tearing effect line off
1	Tearing effect on

## 9.8 Enter Sleep Mode

**Command** 10h  
**Parameters** None

	D/C	D7	D6	D5	D4	D3	D2	D1	D0	Hex
Command	0	0	0	0	1	0	0	0	0	10

### Description

Turn off the panel. This command causes the display panel to enter sleep mode and pull low the GPIO0. If GPIO0 is configured as normal GPIO or LCD miscellaneous signal with command Set GPIO Conf, 0xB8, this command will not affect the GPIO0.

Note :

The host processor must wait 5ms before sending any new commands to a SSD1963 following this command.

The host processor must wait 120ms after sending an Exit Sleep Mode, 0x11 before sending an Enter Sleep Mode, 0x10.

## 9.9 Exit Sleep Mode

**Command** 11h  
**Parameters** None

	D/C	D7	D6	D5	D4	D3	D2	D1	D0	Hex
Command	0	0	0	0	1	0	0	0	1	11

### Description

Turn on the panel. This command causes the display panel to exit sleep mode and will pull high the GPIO0. If GPIO0 is configured as normal GPIO or LCD miscellaneous signal with command Set GPIO Conf (0xB8), this command will not affect the GPIO0.

Note :

The host processor must wait 5ms after sending this command before sending another command.

The host processor must wait 120ms after sending an Exit Sleep Mode, 0x11 before sending an Enter Sleep Mode, 0x10.

## 9.10 Enter Partial Mode

**Command** 12h  
**Parameters** None

	D/C	D7	D6	D5	D4	D3	D2	D1	D0	Hex
Command	0	0	0	0	1	0	0	1	0	12

### Description

This command causes the display module to enter the Partial Display Mode. The Partial Display Mode window is described by the Set Partial Area, 0x30h.

To leave Partial Display Mode, the Enter Normal Mode, 0x13h.

## 9.11 Enter Normal Mode

**Command** 13h  
**Parameters** None

	D/C	D7	D6	D5	D4	D3	D2	D1	D0	Hex
Command	0	0	0	0	1	0	0	1	1	13

### Description

This command causes the display module to enter the normal mode. Normal mode is defined as partial display and scroll mode are off. That means the whole display area is used for image display.

## 9.12 Exit Invert Mode

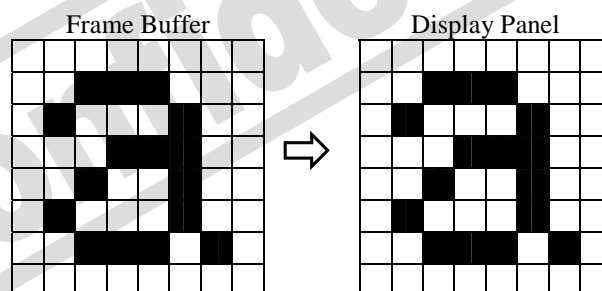
**Command** 20h  
**Parameters** None

	D/C	D7	D6	D5	D4	D3	D2	D1	D0	Hex
Command	0	0	0	1	0	0	0	0	0	20

### Description

This command causes the display module to stop inverting the image data on the display device. The frame buffer contents remain unchanged.

**Figure 9-1: Exit Invert mode example**



## 9.13 Enter Invert Mode

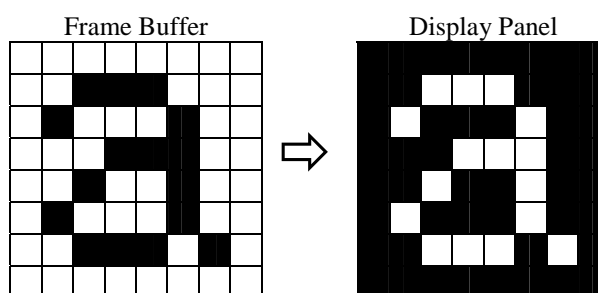
**Command** 21h  
**Parameters** None

	D/C	D7	D6	D5	D4	D3	D2	D1	D0	Hex
Command	0	0	0	1	0	0	0	0	1	21

### Description

This command causes the display module to invert the image data only on the display device. The frame buffer contents remain unchanged.

**Figure 9-2: Enter Invert mode example**



## 9.14 Set Gamma Curve

**Command** 26h  
**Parameters** 1

	D/C	D7	D6	D5	D4	D3	D2	D1	D0	Hex
Command	0	0	0	1	0	0	1	1	0	26
Parameter 1	1	0	0	0	0	A <sub>3</sub>	A <sub>2</sub>	A <sub>1</sub>	A <sub>0</sub>	xx

### Description

Selects the gamma curve used by the display device.

A[3:0]	Gamma curve selection (POR = 1000)	GAMAS[1]	GAMAS[0]
0000	No gamma curve selected (Same as 0001b)	0	0
0001	Gamma curve 0	0	0
0010	Gamma curve 1	0	1
0100	Gamma curve 2	1	0
1000	Gamma curve 3	1	1
Others	Reserved		

## 9.15 Set Display Off

**Command** 28h  
**Parameters** None

	D/C	D7	D6	D5	D4	D3	D2	D1	D0	Hex
Command	0	0	0	1	0	1	0	0	0	28

### Description

Blanks the display device. The frame buffer contents remain unchanged.

## 9.16 Set Display On

**Command** 29h  
**Parameters** None

	D/C	D7	D6	D5	D4	D3	D2	D1	D0	Hex
Command	0	0	0	1	0	1	0	0	1	29

### Description

Show the image on the display device

## 9.17 Set Column Address

**Command** 2Ah  
**Parameters** 4

	D/C	D7	D6	D5	D4	D3	D2	D1	D0	Hex
Command	0	0	0	1	0	1	0	1	0	2A
Parameter 1	1	SC <sub>15</sub>	SC <sub>14</sub>	SC <sub>13</sub>	SC <sub>12</sub>	SC <sub>11</sub>	SC <sub>10</sub>	SC <sub>9</sub>	SC <sub>8</sub>	xx
Parameter 2	1	SC <sub>7</sub>	SC <sub>6</sub>	SC <sub>5</sub>	SC <sub>4</sub>	SC <sub>3</sub>	SC <sub>2</sub>	SC <sub>1</sub>	SC <sub>0</sub>	xx
Parameter 3	1	EC <sub>15</sub>	EC <sub>14</sub>	EC <sub>13</sub>	EC <sub>12</sub>	EC <sub>11</sub>	EC <sub>10</sub>	EC <sub>9</sub>	EC <sub>8</sub>	xx
Parameter 4	1	EC <sub>7</sub>	EC <sub>6</sub>	EC <sub>5</sub>	EC <sub>4</sub>	EC <sub>3</sub>	EC <sub>2</sub>	EC <sub>1</sub>	EC <sub>0</sub>	xx

### Description

Set the column extent of frame buffer accessed by the host processor with the Read Memory Continue, 0x3E and Write Memory Continue, 0x3C..

SC[15:8] : Start column number high byte (POR = 00000000)

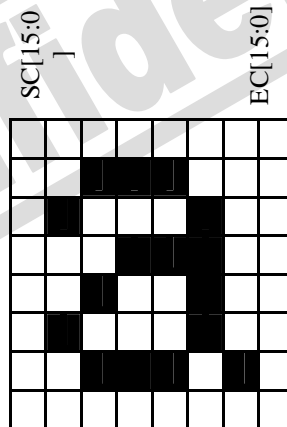
SC[7:0] : Start column number low byte (POR = 00000000)

EC[15:8] : End column number high byte (POR = 00000000)

EC[7:0] : End column number low byte (POR = 00000000)

Note : SC[15:0] must always be equal to or less than EC[15:0]

Figure 9-3: Set Column Address example



## 9.18 Set Page Address

**Command** 2Bh  
**Parameters** 4

	D/C	D7	D6	D5	D4	D3	D2	D1	D0	Hex
Command	0	0	0	1	0	1	0	0	1	2B
Parameter 1	1	SP <sub>15</sub>	SP <sub>14</sub>	SP <sub>13</sub>	SP <sub>12</sub>	SP <sub>11</sub>	SP <sub>10</sub>	SP <sub>9</sub>	SP <sub>8</sub>	xx
Parameter 2	1	SP <sub>7</sub>	SP <sub>6</sub>	SP <sub>5</sub>	SP <sub>4</sub>	SP <sub>3</sub>	SP <sub>2</sub>	SP <sub>1</sub>	SP <sub>0</sub>	xx
Parameter 3	1	EP <sub>15</sub>	EP <sub>14</sub>	EP <sub>13</sub>	EP <sub>12</sub>	EP <sub>11</sub>	EP <sub>10</sub>	EP <sub>9</sub>	EP <sub>8</sub>	xx
Parameter 4	1	EP <sub>7</sub>	EP <sub>6</sub>	EP <sub>5</sub>	EP <sub>4</sub>	EP <sub>3</sub>	EP <sub>2</sub>	EP <sub>1</sub>	EP <sub>0</sub>	xx

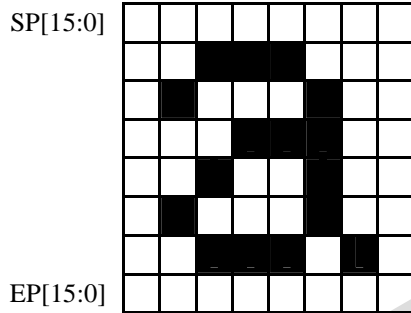
### Description

Set the page extent of the frame buffer accessed by the host processor with the Read Memory Continue, 0x3E and Write Memory Continue, 0x3C..

SP[15:8] : Start page (row) number high byte (POR = 00000000)  
 SP[7:0] : Start page (row) number low byte (POR = 00000000)  
 EP[15:8] : End page (row) number high byte (POR = 00000000)  
 EP[7:0] : End page (row) number low byte (POR = 00000000)

Note : SP[15:0] must always be equal to or less than EP[15:0]

**Figure 9-4: Set Page Address example**



### 9.19 Write Memory Start

**Command** 2Ch  
**Parameters** None

	D/C	D7	D6	D5	D4	D3	D2	D1	D0	Hex
Command	0	0	0	1	0	1	1	0	0	2C

#### Description

Transfer image information from the host processor interface to the SSD1963 starting at the location provided by Set Column Address, 0x2A and Set Page Address, 0x2B.

If Set Address Mode, 0x36 A[5] = 0:

The column and page registers are reset to the Start Column (SC) and Start Page (SP), respectively.

Pixel Data 1 is stored in frame buffer at (SC, SP). The column register is then incremented and pixels are written to the frame memory until the column register equals the End Column (EC) value. The column register is then reset to SC and the page register is incremented. Pixels are written to the frame buffer until the page register equals the End Page (EP) value and the column register equals the EC value, or the host processor sends another command. If the number of pixels exceeds  $(EC - SC + 1) * (EP - SP + 1)$  the extra pixels are ignored.

If Set Address Mode, 0x36 A[5] = 1:

The column and page registers are reset to the Start Column (SC) and Start Page (SP), respectively.

Pixel Data 1 is stored in frame buffer at (SC, SP). The page register is then incremented and pixels are written to the frame memory until the page register equals the End Page (EP) value. The page register is then reset to SP and the column register is incremented. Pixels are written to the frame buffer until the column register equals the End column (EC) value and the page register equals the EP value, or the host processor sends another command. If the number of pixels exceeds  $(EC - SC + 1) * (EP - SP + 1)$  the extra pixels are ignored.

## 9.20 Read Memory Start

**Command** 2Eh  
**Parameters** None

	D/C	D7	D6	D5	D4	D3	D2	D1	D0	Hex
Command	0	0	0	1	0	1	1	1	0	2E

### Description

Transfer image data from the SSD1963 to the host processor interface starting at the location provided by Set Column Address, 0x2A and Set Page Address, 0x2B.

If Set Address Mode, 0x36 A[5] = 0:

The column and page registers are reset to the Start Column (SC) and Start Page (SP), respectively.

Pixels are read from frame buffer at (SC, SP). The column register is then incremented and pixels read from the frame memory until the column register equals the End Column (EC) value. The column register is then reset to SC and the page register is incremented. Pixels are read from the frame buffer until the page register equals the End Page (EP) value and the column register equals the EC value, or the host processor sends another command.

If Set Address Mode, 0x36 A[5] = 1:

The column and page registers are reset to the Start Column (SC) and Start Page (SP), respectively.

Pixels are read from frame buffer at (SC, SP). The page register is then incremented and pixels read from the frame memory until the page register equals the End Page (EP) value. The page register is then reset to SP and the column register is incremented. Pixels are read from the frame buffer until the column register equals the End Column (EC) value and the page register equals the EP value, or the host processor sends another command.

## 9.21 Set Partial Area

**Command** 30h  
**Parameters** 4

	D/C	D7	D6	D5	D4	D3	D2	D1	D0	Hex
Command	0	0	0	1	1	0	0	0	0	30
Parameter 1	1	SR <sub>15</sub>	SR <sub>14</sub>	SR <sub>13</sub>	SR <sub>12</sub>	SR <sub>11</sub>	SR <sub>10</sub>	SR <sub>9</sub>	SR <sub>8</sub>	xx
Parameter 2	1	SR <sub>7</sub>	SR <sub>6</sub>	SR <sub>5</sub>	SR <sub>4</sub>	SR <sub>3</sub>	SR <sub>2</sub>	SR <sub>1</sub>	SR <sub>0</sub>	xx
Parameter 3	1	ER <sub>15</sub>	ER <sub>14</sub>	ER <sub>13</sub>	ER <sub>12</sub>	ER <sub>11</sub>	ER <sub>10</sub>	ER <sub>9</sub>	ER <sub>8</sub>	xx
Parameter 4	1	ER <sub>7</sub>	ER <sub>6</sub>	ER <sub>5</sub>	ER <sub>4</sub>	ER <sub>3</sub>	ER <sub>2</sub>	ER <sub>1</sub>	ER <sub>0</sub>	xx

### Description

This command defines the Partial Display mode's display area. There are two parameters associated with this command, the first defines the Start Row (SR) and the second the End Row (ER). SR and ER refer to the Frame Buffer Line Pointer.

SR[15:8] : Start display row number high byte (POR = 00000000)

SR[7:0] : Start display row number low byte (POR = 00000000)

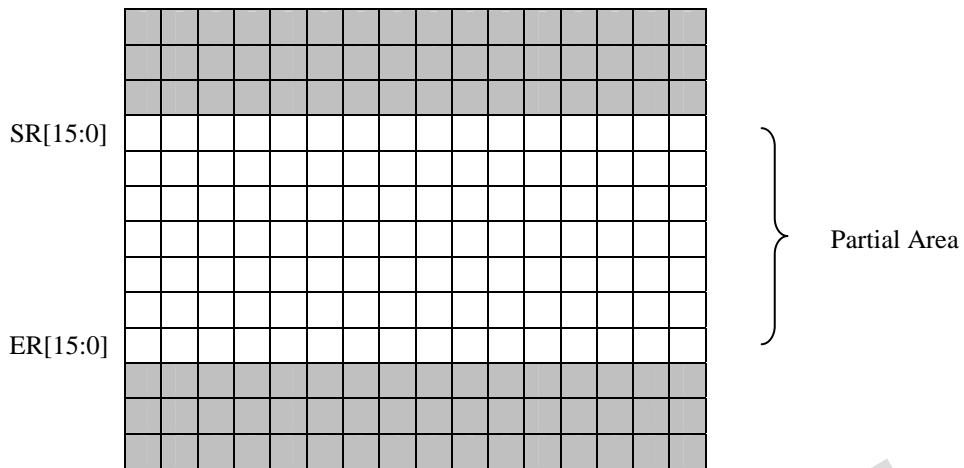
ER[15:8] : End display row number high byte (POR = 00000000)

ER[7:0] : End display row number low byte (POR = 00000000)

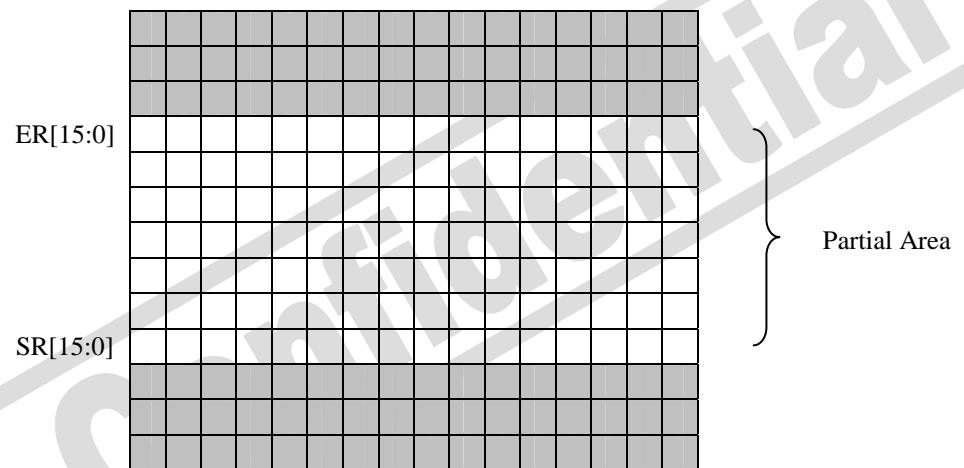
Note : SR[15:0] and ER[15:0] cannot be 0000h nor exceed the last vertical line number.

If End Row > Start Row

**Figure 9-5: Set Partial Area with Set Address Mode 0x36 A[4] = 0**

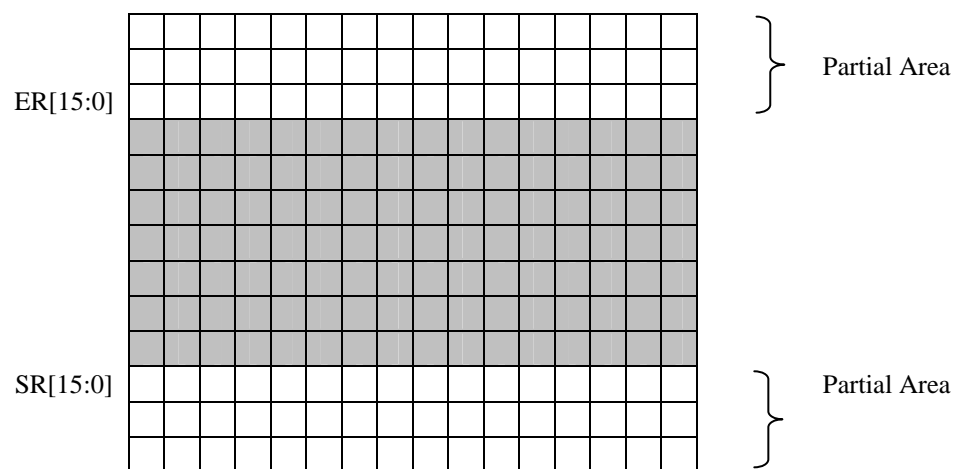


**Figure 9-6: Set Partial Area with Set Address Mode 0x36 A[4] = 1**

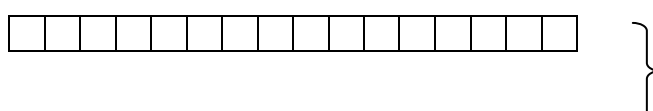


If Start Row > End Row

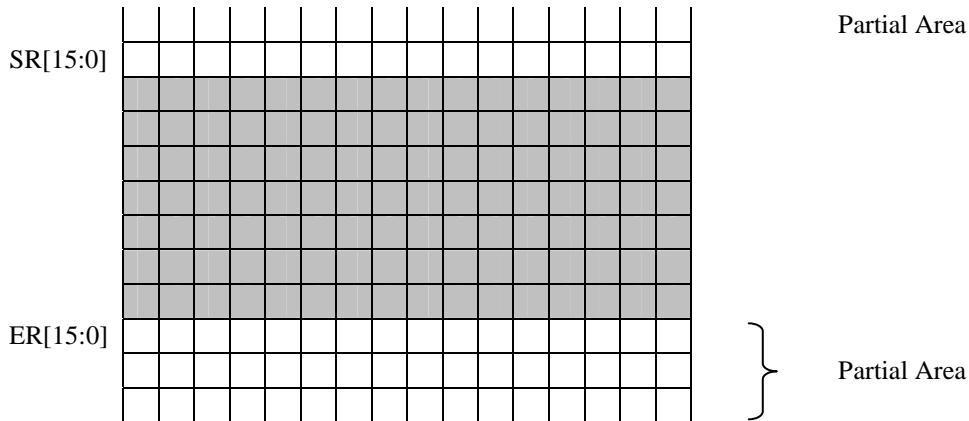
**Figure 9-7: Set Partial Area with Set Address Mode 0x36 A[4] = 0**



**Figure 9-8: Set Partial Area with Set Address Mode 0x36 A[4] = 1**







## 9.22 Set Scroll Area

**Command** 33h  
**Parameters** 6

	D/C	D7	D6	D5	D4	D3	D2	D1	D0	Hex
Command	0	0	0	1	1	0	0	1	1	33
Parameter 1	1	TFA <sub>15</sub>	TFA <sub>14</sub>	TFA <sub>13</sub>	TFA <sub>12</sub>	TFA <sub>11</sub>	TFA <sub>10</sub>	TFA <sub>9</sub>	TFA <sub>8</sub>	xx
Parameter 2	1	TFA <sub>7</sub>	TFA <sub>6</sub>	TFA <sub>5</sub>	TFA <sub>4</sub>	TFA <sub>3</sub>	TFA <sub>2</sub>	TFA <sub>1</sub>	TFA <sub>0</sub>	xx
Parameter 3	1	VSA <sub>15</sub>	VSA <sub>14</sub>	VSA <sub>13</sub>	VSA <sub>12</sub>	VSA <sub>11</sub>	VSA <sub>10</sub>	VSA <sub>9</sub>	VSA <sub>8</sub>	xx
Parameter 4	1	VSA <sub>7</sub>	VSA <sub>6</sub>	VSA <sub>5</sub>	VSA <sub>4</sub>	VSA <sub>3</sub>	VSA <sub>2</sub>	VSA <sub>1</sub>	VSA <sub>0</sub>	xx
Parameter 5	1	BFA <sub>15</sub>	BFA <sub>14</sub>	BFA <sub>13</sub>	BFA <sub>12</sub>	BFA <sub>11</sub>	BFA <sub>10</sub>	BFA <sub>9</sub>	BFA <sub>8</sub>	xx
Parameter 6	1	BFA <sub>7</sub>	BFA <sub>6</sub>	BFA <sub>5</sub>	BFA <sub>4</sub>	BFA <sub>3</sub>	BFA <sub>2</sub>	BFA <sub>1</sub>	BFA <sub>0</sub>	xx

### Description

Defines the vertical scrolling and fixed area on display area

TFA[15:8] : High byte of Top Fixed Area number in lines from the top of the frame buffer (POR = 00000000)

TFA[7:0] : Low byte of Top Fixed Area number in lines from the top of the frame buffer (POR = 00000000)

VSA[15:8] : High byte of Vertical scrolling area in number of lines of the frame buffer (POR = 00000000)

VSA[7:0] : Low byte of Vertical scrolling area in number of lines of the frame buffer (POR = 00000000)

BFA[15:8] : High byte of Bottom Fixed Area in number of lines from the bottom of the frame buffer (POR = 00000000)

BFA[7:0] : Low byte of Bottom Fixed Area in number of lines from the bottom of the frame buffer (POR = 00000000)

If Set Address Mode, 0x36 A[4] = 0 :

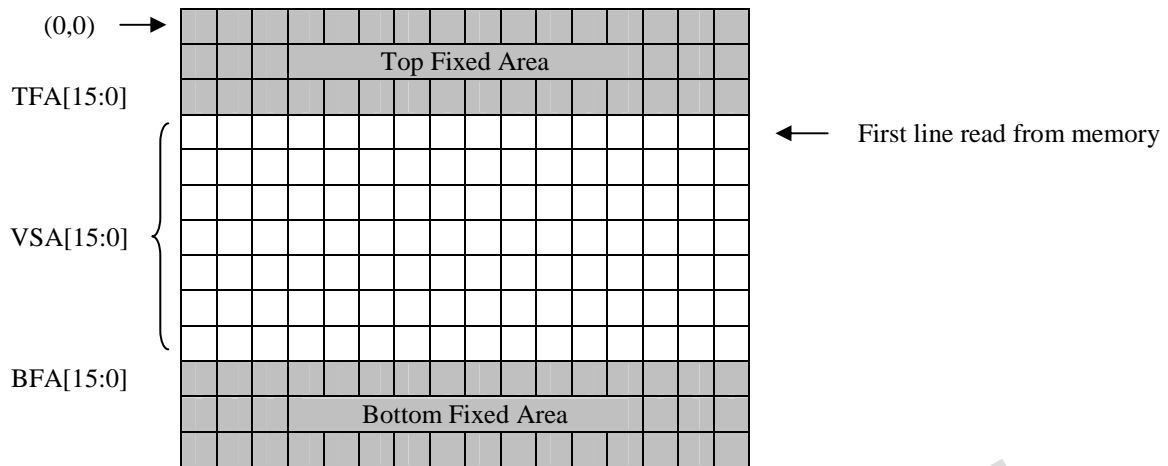
The TFA[15:0] describes the Top Fixed Area in number of lines from the top of the frame buffer. The top of the frame buffer and top of the display panel are aligned.

The VSA[15:0] describes the height of the Vertical Scrolling Area in number of lines of frame buffer from the Vertical Scrolling Start Address. The first line of the Vertical Scrolling Area starts immediately after the bottom most line of the Top Fixed Area. The last line of the Vertical Scrolling Area ends immediately before the top most line of the Bottom Fixed Area.

The BFA[15:0] describes the Bottom Fixed Area in number of lines from the bottom of the frame buffer. The bottom of the frame buffer and bottom of the display panel are aligned.

TFA, VSA and BFA refer to the Frame Buffer Line Pointer.

**Figure 9-9: Set Scroll Area with Set Address Mode 0x36 A[4] = 0**



If Set Address Mode, 0x36 A[4] = 1 :

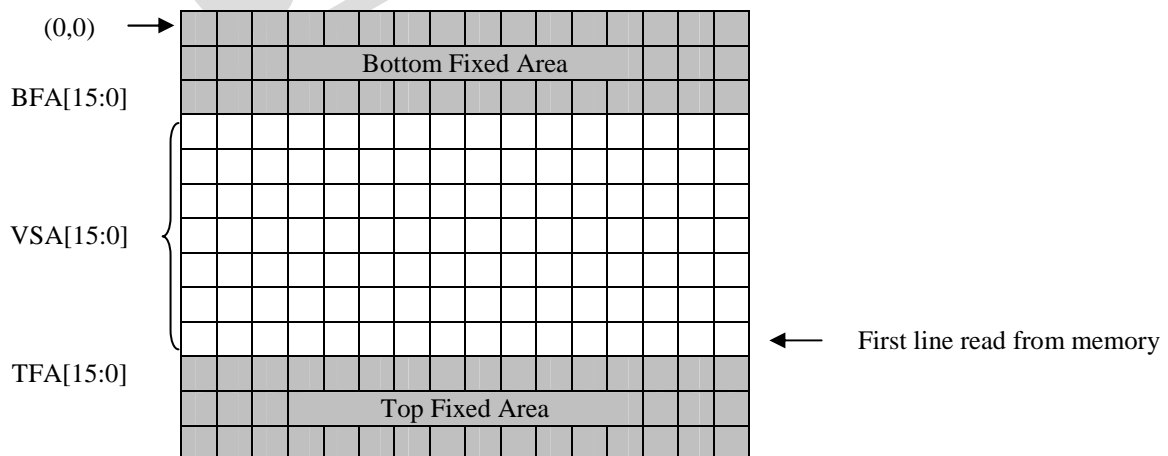
The TFA[15:0], describes the Top Fixed Area in number of lines from the bottom of the frame buffer. The bottom of the frame buffer and bottom of the display panel are aligned.

The VSA[15:0] describes the height of the Vertical Scrolling Area in number of lines of frame buffer from the Vertical Scrolling Start Address. The first line of the Vertical Scrolling Area starts immediately after the top most line of the Top Fixed Area. The last line of the Vertical Scrolling Area ends immediately before the bottom most line of the Bottom Fixed Area.

The BFA[15:0] describes the Bottom Fixed Area in number of lines from the top of the frame buffer. The top of the frame buffer and top of the display panel are aligned.

TFA, VSA and BFA refer to the Frame Buffer Line Pointer.

**Figure 9-10: Set Scroll Area with Set Address Mode 0x36 A[4] = 1**



Note :

The sum of TFA, VSA and BFA must equal the number of the display panel's horizontal lines (pages), otherwise Scrolling mode is undefined.

In Vertical Scroll Mode, Set Address Mode, 0x36 A[5] should be set to '0' – this only affects the Frame Memory Write.

### 9.23 Set Tear Off

**Command** 34h  
**Parameters** None

	D/C	D7	D6	D5	D4	D3	D2	D1	D0	Hex
Command	0	0	0	1	1	0	1	0	0	34

#### Description

TE signal is not sent from the display module to the host processor.

### 9.24 Set Tear On

**Command** 35h  
**Parameters** 1

	D/C	D7	D6	D5	D4	D3	D2	D1	D0	Hex
Command	0	0	0	1	1	0	1	0	1	35
Parameter 1	1	0	0	0	0	0	0	0	A <sub>0</sub>	xx

#### Description

TE signal is sent from the display module to the host processor at the start of VFP.

A[0] : Tearing effect line mode (POR = 0)

- 0 The tearing effect output line consists of V-blanking information only.
- 1 The tearing effect output line consists of both V-blanking and H-blanking information.

The TE signal shall be active low when the display panel is in Sleep mode.

### 9.25 Set Address Mode

**Command** 36h  
**Parameters** 1

	D/C	D7	D6	D5	D4	D3	D2	D1	D0	Hex
Command	0	0	0	1	1	0	1	1	0	36
Parameter 1	1	A <sub>7</sub>	A <sub>6</sub>	A <sub>5</sub>	A <sub>4</sub>	A <sub>3</sub>	A <sub>2</sub>	A <sub>1</sub>	A <sub>0</sub>	xx

#### Description

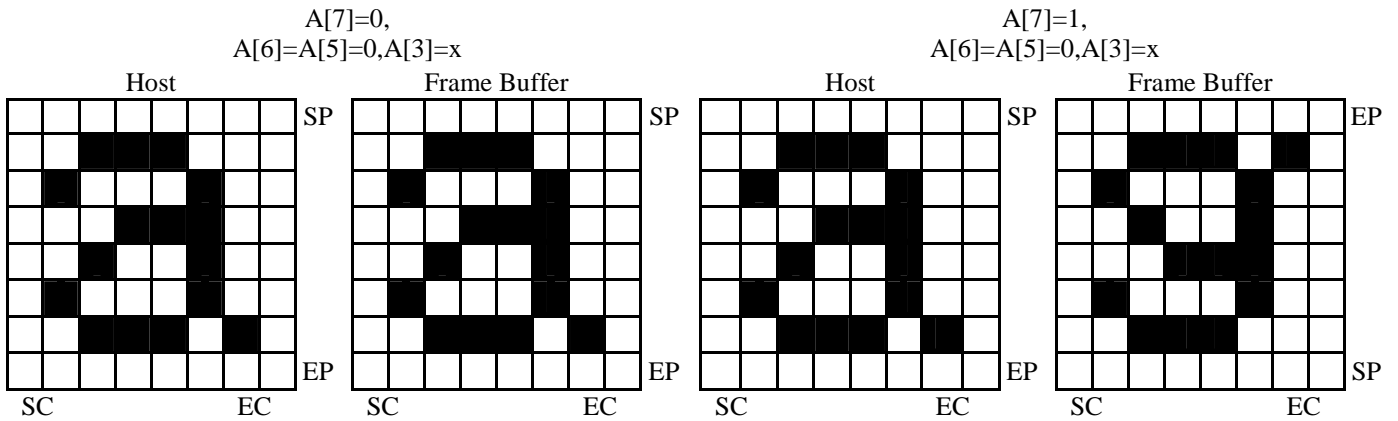
Set the read order from host processor to frame buffer by A[7:5] and A[3] and from frame buffer to the display panel by A[2:0] and A[4].

A[7] : Page address order (POR = 0)

This bit controls the order that pages of data are transferred from the host processor to the SSD1963's frame buffer.

- 0 Top to bottom, pages transferred from SP (Start Page) to EP (End Page).
- 1 Bottom to top, pages transferred from EP (End Page) to SP (Start Page).

**Figure 9-11: A[7] Page Address Order**

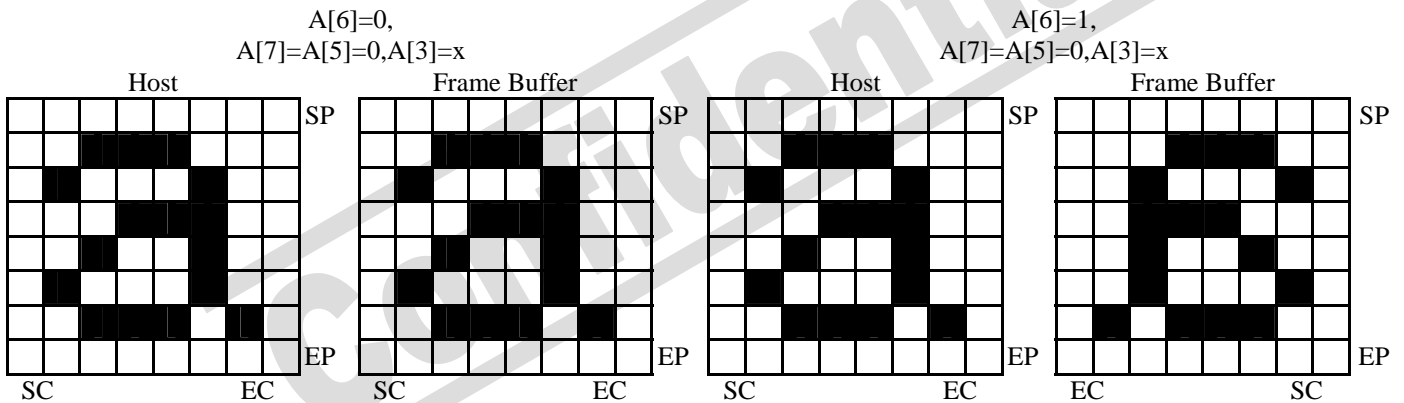


A[6] : Column address order (POR = 0)

This bit controls the order that columns of data are transferred from the host processor to the SSD1963's frame buffer.

- 0 Left to right, columns transferred from SC (Start Column) to EC (End Column).
- 1 Right to left, columns transferred from EC (End Column) to SC (Start Column).

**Figure 9-12: A[6] Column Address Order**

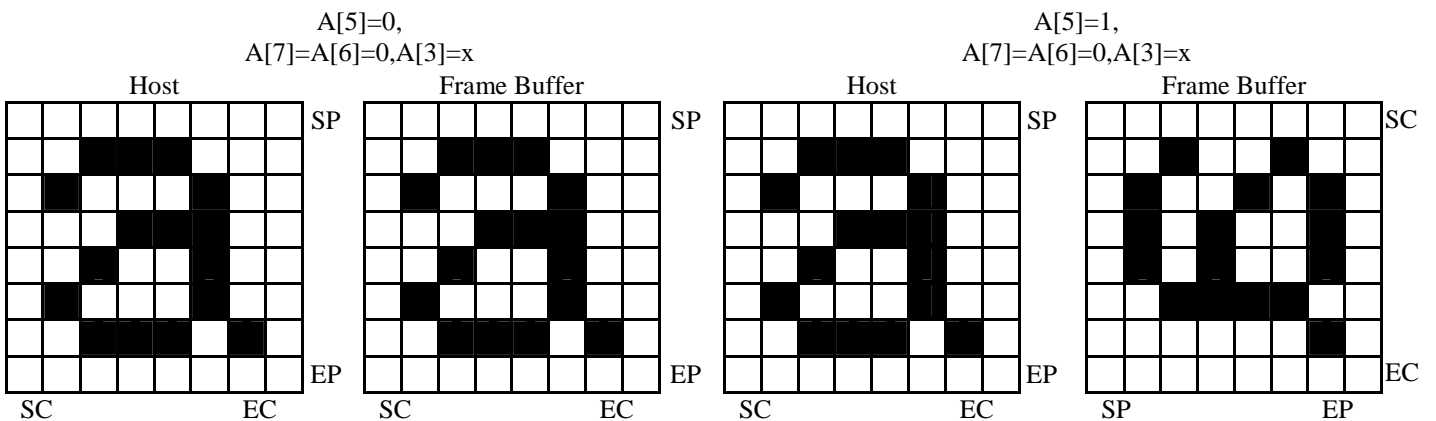


A[5] : Page / Column order (POR = 0)

This bit controls the order that columns of data are transferred from the host processor to the SSD1963's frame buffer.

- 0 Normal mode
- 1 Reverse mode

**Figure 9-13: A[5] Page / Column Address Order**



A[4] : Line address order (POR = 0)

This bit controls the display panel's horizontal line refresh order. The image shown on the display panel is unaffected, regardless of the bit setting.

- 0 LCD refresh from top line to bottom line.
- 1 LCD refresh from bottom line to top line.

A[3] : RGB / BGR order (POR = 0)

This bit controls the RGB data order transferred from the SSD1963's frame buffer to the display panel.

- 0 RGB
- 1 BGR

**Figure 9-14: A[3] RGB Order**



A[2] : Display data latch data (POR = 0)

This bit controls the display panel's vertical line data latch order. The image shown on the display panel is unaffected, regardless of the bit setting.

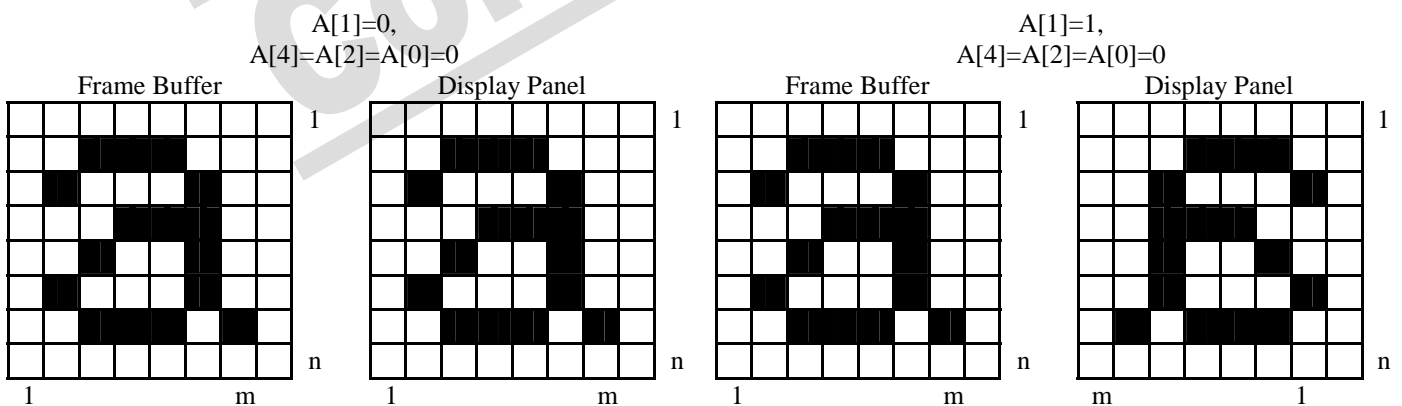
- 0 LCD refresh from left side to right side
- 1 LCD refresh from right side to left side

A[1] : Flip Horizontal (POR = 0)

This bit flips the image shown on the display panel left to right. No change is made to the frame memory.

- 0 Normal
- 1 Flipped

**Figure 9-15: A[1] Flip Horizontal**

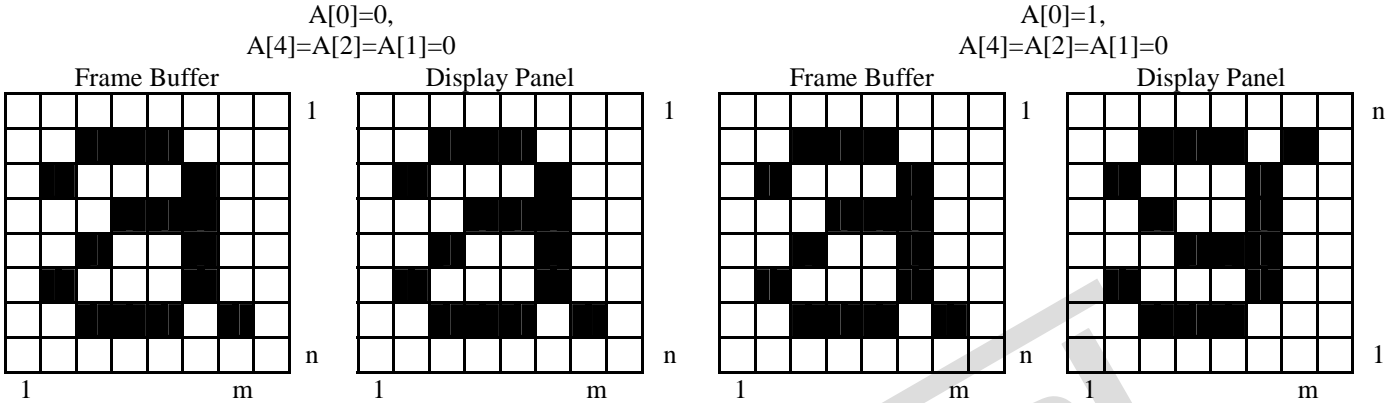


A[0] : Flip Vertical (POR = 0)

This bit flips the image shown on the display panel top to bottom. No change is made to the frame memory.

- 0 Normal
- 1 Flipped

Figure 9-16: A[0] Flip Vertical



### 9.26 Set Scroll Start

Command 37h  
Parameters 2

	D/C	D7	D6	D5	D4	D3	D2	D1	D0	Hex
Command	0	0	0	1	1	0	1	1	1	37
Parameter 1	1	VSP <sub>15</sub>	VSP <sub>14</sub>	VSP <sub>13</sub>	VSP <sub>12</sub>	VSP <sub>11</sub>	VSP <sub>10</sub>	VSP <sub>9</sub>	VSP <sub>8</sub>	xx
Parameter 2	1	VSP <sub>7</sub>	VSP <sub>6</sub>	VSP <sub>5</sub>	VSP <sub>4</sub>	VSP <sub>3</sub>	VSP <sub>2</sub>	VSP <sub>1</sub>	VSP <sub>0</sub>	xx

#### Description

This command sets the start of the vertical scrolling area in the frame buffer. The vertical scrolling area is fully defined when this command is used with the Set Scroll Area 0x33.

VSP[15:8] : High byte of Vertical Scroll Pointer to define the line number in frame buffer that is written to the display as the first line of the vertical scrolling area (POR = 00000000)

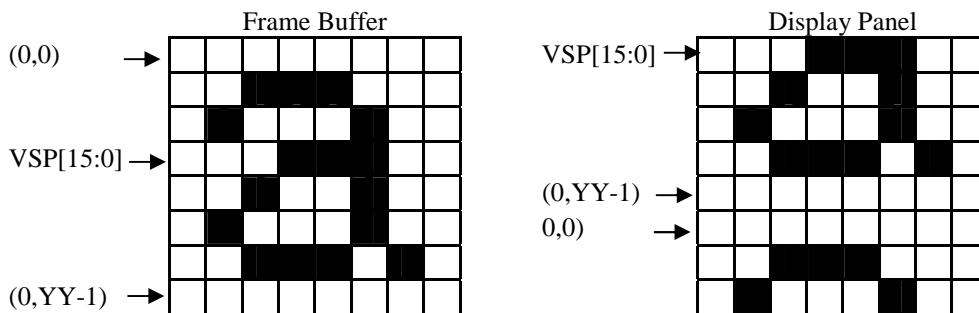
VSP[7:0] : Low byte of Vertical Scroll Pointer to define the line number in frame buffer that is written to the display as the first line of the vertical scrolling area (POR = 00000000)

If Set Address Mode, 0x36 A[4] = 0:

Example:

When Top Fixed Area = Bottom Fixed Area = 0, Vertical Scrolling Area = YY and VSP = 3.

Figure 9-17: Set Scroll Start with Set Address Mode, 0x36 A[4] = 0

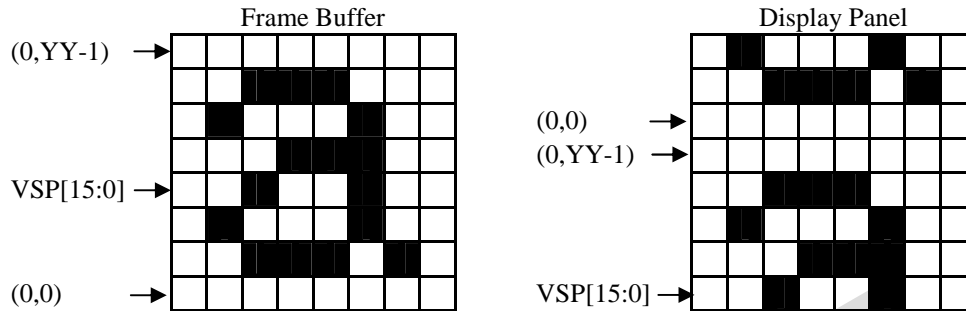


If Set Address Mode, 0x36 A[4] = 1:

Example:

When Top Fixed Area = Bottom Fixed Area = 0, Vertical Scrolling Area = YY and VSP = 3.

**Figure 9-18: Set Scroll Start with Set Address Mode, 0x36 A[4] = 1**



Note :

If Set Address Mode, 0x36 A[4] = 0,  $TFA[15:0] - 1 < VSP[15:0] < \# \text{ of lines in frame buffer} - BFA[15:0]$

If Set Address Mode, 0x36 A[4] = 1,  $BFA[15:0] - 1 < VSP[15:0] < \# \text{ of lines in frame buffer} - TFA[15:0]$

## 9.27 Exit Idle Mode

**Command** 38h  
**Parameters** None

	D/C	D7	D6	D5	D4	D3	D2	D1	D0	Hex
Command	0	0	0	1	1	1	0	0	0	38

### Description

This command causes the display module to exit Idle Mode.

Full color depth is used for the display panel.

## 9.28 Enter Idle Mode

**Command** 39h  
**Parameters** None

	D/C	D7	D6	D5	D4	D3	D2	D1	D0	Hex
Command	0	0	0	1	1	1	0	0	1	39

### Description

This command causes the display module to enter Idle Mode.

In Idle Mode, color depth is reduced. Colors are shown on the display panel using the MSB of each of the R, G and B color components in the frame buffer.

**Table 9-1 Enter Idle Mode memory content vs display color**

Color	R <sub>7</sub> R <sub>6</sub> R <sub>5</sub> R <sub>4</sub> R <sub>3</sub> R <sub>2</sub> R <sub>1</sub> R <sub>0</sub>	G <sub>7</sub> G <sub>6</sub> G <sub>5</sub> G <sub>4</sub> G <sub>3</sub> G <sub>2</sub> G <sub>1</sub> G <sub>0</sub>	B <sub>7</sub> B <sub>6</sub> B <sub>5</sub> B <sub>4</sub> B <sub>3</sub> B <sub>2</sub> B <sub>1</sub> B <sub>0</sub>
Black	0XXXXXXXX	0XXXXXXXX	0XXXXXXXX
Blue	0XXXXXXXX	0XXXXXXXX	1XXXXXXXX
Red	1XXXXXXXX	0XXXXXXXX	0XXXXXXXX
Magenta	1XXXXXXXX	0XXXXXXXX	1XXXXXXXX
Green	0XXXXXXXX	1XXXXXXXX	0XXXXXXXX
Cyan	0XXXXXXXX	1XXXXXXXX	1XXXXXXXX
Yellow	1XXXXXXXX	1XXXXXXXX	0XXXXXXXX
White	1XXXXXXXX	1XXXXXXXX	1XXXXXXXX

### 9.29 Set Pixel Format

**Command** 3Ah  
**Parameters** 1

	D/C	D7	D6	D5	D4	D3	D2	D1	D0	Hex
Command	0	0	0	1	1	1	0	1	0	3A
Parameter 1	1	0	A <sub>6</sub>	A <sub>5</sub>	A <sub>4</sub>	0	0	0	0	xx

#### Description

Set the current pixel format for RGB image data

A[6:4] : Display pixel format (POR = 000)

- 000 Reserved
- 001 3-bit/pixel
- 010 8-bit/pixel
- 011 12-bit/pixel
- 100 Reserved
- 101 16-bit/pixel
- 110 18-bit/pixel
- 111 24-bit/pixel

### 9.30 Write Memory Continue

**Command** 3Ch  
**Parameters** None

	D/C	D7	D6	D5	D4	D3	D2	D1	D0	Hex
Command	0	0	0	1	1	1	1	0	0	3C

#### Description

Transfer image information from the host processor interface to the SSD1963 from the last Write Memory Continue, 0x3C or Write Memory Start, 0x2C.



If Set Address Mode, 0x36 A[5] = 0:

Data is written continuing from the pixel location after the write range of the previous Write Memory Start, 0x2C or Write Memory Continue, 0x3C. The column register is then incremented and pixels are written to the frame buffer until the column register equals the End Column (EC) value. The column register is then reset to SC and the page register is incremented. Pixels are written to the frame buffer until the page register equals the End Page (EP) value and the column register equals the EC value, or the host processor sends another command. If the number of pixels exceeds  $(EC - SC + 1) * (EP - SP + 1)$  the extra pixels are ignored.

If Set Address Mode, 0x36 A[5] = 1:

Data is written continuing from the pixel location after the write range of the previous Write Memory Start, 0x2C or Write Memory Continue, 0x3C. The page register is then incremented and pixels are written to the frame buffer until the page register equals the End Page (EP) value. The page register is then reset to SP and the column register is incremented. Pixels are written to the frame buffer until the column register equals the End column (EC) value and the page register equals the EP value, or the host processor sends another command. If the number of pixels exceeds  $(EC - SC + 1) * (EP - SP + 1)$  the extra pixels are ignored.

### 9.31 Read Memory Continue

**Command** 3Eh  
**Parameters** None

	D/C	D7	D6	D5	D4	D3	D2	D1	D0	Hex
Command	0	0	0	1	1	1	1	1	0	3E

#### Description

Read image data from the SSD1963 to host processor continuing after the last Read Memory Continue, 0x3E or Read Memory Start, 0x2E.

If Set Address Mode, 0x36 A[5] = 0:

Pixels are read continuing from the pixel location after the read range of the previous Read Memory Start, 0x2E or Read Memory Continue, 0x3E. The column register is then incremented and pixels are read from the frame buffer until the column register equals the End Column (EC) value. The column register is then reset to SC and the page register is incremented. Pixels are read from the frame buffer until the page register equals the End Page (EP) value and the column register equals the EC value, or the host processor sends another command.

If Set Address Mode, 0x36 A[5] = 1:

Pixels are read continuing from the pixel location after the read range of the previous Read Memory Start, 0x2E or Read Memory Continue, 0x3E. The page register is then incremented and pixels are read from the frame buffer until the page register equals the End Page (EP) value. The page register is then reset to SP and the column register is incremented. Pixels are read from the frame buffer until the column register equals the End Column (EC) value and the page register equals the EP value, or the host processor sends another command.

### 9.32 Set Tear Scanline

**Command** 44h  
**Parameters** 2

	D/C	D7	D6	D5	D4	D3	D2	D1	D0	Hex
Command	0	0	1	0	0	0	1	0	0	44
Parameter 1	1	N <sub>15</sub>	N <sub>14</sub>	N <sub>13</sub>	N <sub>12</sub>	N <sub>11</sub>	N <sub>10</sub>	N <sub>9</sub>	N <sub>8</sub>	xx
Parameter 2	1	N <sub>7</sub>	N <sub>6</sub>	N <sub>5</sub>	N <sub>4</sub>	N <sub>3</sub>	N <sub>2</sub>	N <sub>1</sub>	N <sub>0</sub>	xx

#### Description

TE signal is sent from the display module to the host processor when the display device refresh reaches the provided scanline, N.

N[15:8] : High byte of the scanline, N (POR = 00000000)

N[7:0] : Low byte of the scanline, N (POR = 00000000)

Note :

Set Tear Scanline with N = 0 is equivalent to Set Tear On, 0x35 A[0] = 0.

This command takes affect on the frame following the current frame. Therefore, if the Tear Effect (TE) signal is already ON, the TE output shall continue to operate as programmed by the previous Set Tear On, 0x35 or Set Tear Scanline, 0x44 until the end of the frame.

### 9.33 Get Tear Scanline

**Command** 45h  
**Parameters** 2

	D/C	D7	D6	D5	D4	D3	D2	D1	D0	Hex
Command	0	0	1	0	0	0	1	0	1	45
Parameter 1	1	N <sub>15</sub>	N <sub>14</sub>	N <sub>13</sub>	N <sub>12</sub>	N <sub>11</sub>	N <sub>10</sub>	N <sub>9</sub>	N <sub>8</sub>	xx
Parameter 2	1	N <sub>7</sub>	N <sub>6</sub>	N <sub>5</sub>	N <sub>4</sub>	N <sub>3</sub>	N <sub>2</sub>	N <sub>1</sub>	N <sub>0</sub>	xx

#### Description

Get the current scan line, N.

N[15:8] : High byte of the current scanline (POR = 00000000)

N[7:0] : Low byte of the current scanline (POR = 00000000)

### 9.34 Read DDB

**Command** A1h  
**Parameters** 5

	D/C	D7	D6	D5	D4	D3	D2	D1	D0	Hex
Command	0	1	0	1	0	0	0	0	1	A1
Parameter 1	1	SSL <sub>15</sub>	SSL <sub>14</sub>	SSL <sub>13</sub>	SSL <sub>12</sub>	SSL <sub>11</sub>	SSL <sub>10</sub>	SSL <sub>9</sub>	SSL <sub>8</sub>	xx
Parameter 2	1	SSL <sub>7</sub>	SSL <sub>6</sub>	SSL <sub>5</sub>	SSL <sub>4</sub>	SSL <sub>3</sub>	SSL <sub>2</sub>	SSL <sub>1</sub>	SSL <sub>0</sub>	xx
Parameter 3	1	PROD <sub>7</sub>	PROD <sub>6</sub>	PROD <sub>5</sub>	PROD <sub>4</sub>	PROD <sub>3</sub>	PROD <sub>2</sub>	PROD <sub>1</sub>	PROD <sub>0</sub>	xx
Parameter 4	1	0	0	0	0	0	REV <sub>2</sub>	REV <sub>1</sub>	REV <sub>0</sub>	xx
Parameter 5	1	1	1	1	1	1	1	1	1	FF

#### Description

Read the DDB (Device Descriptor Block) information of SSD1963.

SSL[15:8] : Supplier ID of Solomon Systech Limited high byte, always 01h (POR = 00000001)

SSL[7:0] : Supplier ID of Solomon Systech Limited low byte, always 57h (POR = 010101110)

PROD[7:0] : Product ID, always 61h (POR = 01100001)

REV[2:0] : Revision code, always 01h (POR = 001)

Exit code, always FFh (POR = 11111111)

### 9.35 Set LCD Mode

**Command** B0h  
**Parameters** 7

	D/C	D7	D6	D5	D4	D3	D2	D1	D0	Hex
Command	0	1	0	1	1	0	0	0	0	B0
Parameter 1	1	0	0	A <sub>5</sub>	A <sub>4</sub>	A <sub>3</sub>	A <sub>2</sub>	A <sub>1</sub>	A <sub>0</sub>	xx
Parameter 2	1	B <sub>7</sub>	B <sub>6</sub>	B <sub>5</sub>	0	0	0	0	0	xx
Parameter 3	1	0	0	0	0	0	HPS <sub>10</sub>	HPS <sub>9</sub>	HPS <sub>8</sub>	xx
Parameter 4	1	HPS <sub>7</sub>	HPS <sub>6</sub>	HPS <sub>5</sub>	HPS <sub>4</sub>	HPS <sub>3</sub>	HPS <sub>2</sub>	HPS <sub>1</sub>	HPS <sub>0</sub>	xx
Parameter 5	1	0	0	0	0	0	VPS <sub>10</sub>	VPS <sub>9</sub>	VPS <sub>8</sub>	xx
Parameter 6	1	VPS <sub>7</sub>	VPS <sub>6</sub>	VPS <sub>5</sub>	VPS <sub>4</sub>	VPS <sub>3</sub>	VPS <sub>2</sub>	VPS <sub>1</sub>	VPS <sub>0</sub>	xx
Parameter 7	1	0	0	G <sub>5</sub>	G <sub>4</sub>	G <sub>3</sub>	G <sub>2</sub>	G <sub>1</sub>	G <sub>0</sub>	xx

#### Description

Set the LCD panel mode (RGB TFT or TTL) and pad strength

A[5] : TFT panel data width (POR = 0)

- 0 18-bit
- 1 24-bit

A[4] : TFT color depth enhancement enable (POR = 0)

- 0 Disable FRC or dithering
- 1 Enable FRC or dithering for color depth enhancement

If the panel data width was set to 24-bit, FRC and dithering feature will be disabled automatic regardless the value of this register.

A[3] : TFT FRC enable (POR = 0)

- 0 TFT dithering enable
- 1 TFT FRC enable

A[2] : LSHIFT polarity (POR = 0)

Set the dot clock pulse polarity.

- |   |                            |
|---|----------------------------|
| 0 | Data latch in rising edge  |
| 1 | Data latch in falling edge |

A[1] : LLINE polarity (POR = 0)

Set the horizontal sync pulse polarity.

- |   |             |
|---|-------------|
| 0 | Active low  |
| 1 | Active high |

A[0] : LFRAME polarity (POR = 0)

Set the vertical sync pulse polarity.

- |   |             |
|---|-------------|
| 0 | Active low  |
| 1 | Active high |

B[7] : LCD panel mode (POR = 0)

- |   |                      |
|---|----------------------|
| 0 | Hsync+Vsync +DE mode |
| 1 | TTL mode             |

B[6:5] : TFT type (POR = 01)

- |        |                       |
|--------|-----------------------|
| 00, 01 | TFT mode              |
| 10     | Serial RGB mode       |
| 11     | Serial RGB+dummy mode |

HPS[10:8] : Set the horizontal panel size (POR = 010)

HPS[7:0] : Set the horizontal panel size (POR = 01111111)

Horizontal panel size = (HPS + 1) pixels

VPS[10:8] : Set the vertical panel size (POR = 001)

VPS[7:0] : Set the vertical panel size (POR = 11011111)

Vertical panel size = (VPS + 1) lines

G[5:3] : Even line RGB sequence (POR = 000)

- |     |          |
|-----|----------|
| 000 | RGB      |
| 001 | RBG      |
| 010 | GRB      |
| 011 | GBR      |
| 100 | BRG      |
| 101 | BGR      |
| 11x | Reserved |

G[2:1] : Odd line RGB sequence (POR = 000)

- |     |          |
|-----|----------|
| 000 | RGB      |
| 001 | RBG      |
| 010 | GRB      |
| 011 | GBR      |
| 100 | BRG      |
| 101 | BGR      |
| 11x | Reserved |

### 9.36 Get LCD Mode

**Command** B1h  
**Parameters** 7

	D/C	D7	D6	D5	D4	D3	D2	D1	D0	Hex
Command	0	1	0	1	1	0	0	0	1	B1
Parameter 1	1	0	0	A <sub>5</sub>	A <sub>4</sub>	A <sub>3</sub>	A <sub>2</sub>	A <sub>1</sub>	A <sub>0</sub>	xx
Parameter 2	1	B <sub>7</sub>	B <sub>6</sub>	B <sub>5</sub>	0	0	0	0	0	xx
Parameter 3	1	0	0	0	0	0	HPS <sub>10</sub>	HPS <sub>9</sub>	HPS <sub>8</sub>	xx
Parameter 4	1	HPS <sub>7</sub>	HPS <sub>6</sub>	HPS <sub>5</sub>	HPS <sub>4</sub>	HPS <sub>3</sub>	HPS <sub>2</sub>	HPS <sub>1</sub>	HPS <sub>0</sub>	xx
Parameter 5	1	0	0	0	0	0	VPS <sub>10</sub>	VPS <sub>9</sub>	VPS <sub>8</sub>	xx
Parameter 6	1	VPS <sub>7</sub>	VPS <sub>6</sub>	VPS <sub>5</sub>	VPS <sub>4</sub>	VPS <sub>3</sub>	VPS <sub>2</sub>	VPS <sub>1</sub>	VPS <sub>0</sub>	xx
Parameter 7	1	0	0	G <sub>5</sub>	G <sub>4</sub>	G <sub>3</sub>	G <sub>2</sub>	G <sub>1</sub>	G <sub>0</sub>	xx

#### Description

Get the current LCD panel mode and resolution

A[5] : TFT panel data width(POR = 0)

- 0 18-bit
- 1 24-bit

A[4] : TFT color depth enhancement enable(POR = 0)

- 0 Disable FRC or dithering
- 1 Enable FRC or dithering for color depth enhancement

If the panel data width was set to 24-bit, FRC and dithering feature will be disabled automatic regardless the value of this register.

A[3] : TFT FRC enable (POR = 0)

- 0 TFT dithering enable
- 1 TFT FRC enable

A[2] : LSHIFT polarity (POR = 0)

The dot clock pulse polarity.

- 0 Data latch in rising edge
- 1 Data latch in falling edge

A[1] : LLINE polarity (POR = 0)

The horizontal sync pulse polarity.

- 0 Active low
- 1 Active high

A[0] : LFRAME polarity (POR = 0)

The vertical sync pulse polarity.

- 0 Active low
- 1 Active high

B[7] : LCD panel mode(POR = 0)

- 0 Hsync+Vsync +DE mode
- 1 TTL mode

B[6:5] : TFT type(POR = 01)

- 00 Reserved
- 01 TFT mode
- 10 Serial RGB mode
- 11 Serial RGB+dummy mode

HPS[10:8] : The horizontal panel size (POR = 010)  
HPS[7:0] : The horizontal panel size (POR = 01111111)

VPS[10:8] : The vertical panel size (POR = 001)  
VPS[7:0] : The vertical panel size (POR = 11011111)

G[5:3] : Even line RGB sequence (POR = 000)

000 RGB  
001 RBG  
010 GRB  
011 GBR  
100 BRG  
101 BGR  
11x Reserved

G[2:1] : Odd line RGB sequence (POR = 000)

000 RGB  
001 RBG  
010 GRB  
011 GBR  
100 BRG  
101 BGR  
11x Reserved

### 9.37 Set Horizontal Period

**Command** B4h  
**Parameters** 8

	D/C	D7	D6	D5	D4	D3	D2	D1	D0	Hex
Command	0	1	0	1	1	0	1	0	0	B4
Parameter 1	1	0	0	0	0	0	HT <sub>10</sub>	HT <sub>9</sub>	HT <sub>8</sub>	xx
Parameter 2	1	HT <sub>7</sub>	HT <sub>6</sub>	HT <sub>5</sub>	HT <sub>4</sub>	HT <sub>3</sub>	HT <sub>2</sub>	HT <sub>1</sub>	HT <sub>0</sub>	xx
Parameter 3	1	0	0	0	0	0	HPS <sub>10</sub>	HPS <sub>9</sub>	HPS <sub>8</sub>	xx
Parameter 4	1	HPS <sub>7</sub>	HPS <sub>6</sub>	HPS <sub>5</sub>	HPS <sub>4</sub>	HPS <sub>3</sub>	HPS <sub>2</sub>	HPS <sub>1</sub>	HPS <sub>0</sub>	xx
Parameter 5	1	0	HPW <sub>6</sub>	HPW <sub>5</sub>	HPW <sub>4</sub>	HPW <sub>3</sub>	HPW <sub>2</sub>	HPW <sub>1</sub>	HPW <sub>0</sub>	xx
Parameter 6	1	0	0	0	0	0	LPS <sub>10</sub>	LPS <sub>9</sub>	LPS <sub>8</sub>	xx
Parameter 7	1	LPS <sub>7</sub>	LPS <sub>6</sub>	LPS <sub>5</sub>	LPS <sub>4</sub>	LPS <sub>3</sub>	LPS <sub>2</sub>	LPS <sub>1</sub>	LPS <sub>0</sub>	xx
Parameter 8	1	0	0	0	0	0	0	LPSPP <sub>1</sub>	LPSPP <sub>0</sub>	xx

#### Description

Set front porch

HT[10:8] : High byte of horizontal total period (display + non-display) in pixel clock (POR = 010)  
HT[7:0] : Low byte of the horizontal total period (display + non-display) in pixel clock (POR = 10101111)  
Horizontal total period = (HT + 1) pixels

HPS[10:8] : High byte of the non-display period between the start of the horizontal sync (LLINE) signal and the first display data. (POR = 000)

HPS[7:0] : Low byte of the non-display period between the start of the horizontal sync (LLINE) signal and the first display data. (POR = 00100000)

For TFT : Horizontal Sync Pulse Start Position = (HPS + 1) pixels

For Serial TFT : Horizontal Sync Pulse Start Position = (HPS + 1) pixels + LPSPP subpixels

HPW[6:0] : Set the horizontal sync pulse width (LLINE) in pixel clock. (POR = 000111)  
Horizontal Sync Pulse Width = (HPW + 1) pixels

LPS[10:8] : Set the horizontal sync pulse (LLINE) start location in pixel clock. (POR = 000)  
LPS[7:0] : Set the horizontal sync pulse width (LLINE) in start. (POR = 00000000)  
Horizontal Display Period Start Position = LPS pixels

LPSPP[1:0] : Set the horizontal sync pulse subpixel start position (POR = 00)

Timing refer to Figure 13-4.

### 9.38 Get Horizontal Period

**Command** B5h  
**Parameters** 8

	D/C	D7	D6	D5	D4	D3	D2	D1	D0	Hex
Command	0	1	0	1	1	0	1	0	1	B5
Parameter 1	1	0	0	0	0	0	HT <sub>10</sub>	HT <sub>9</sub>	HT <sub>8</sub>	xx
Parameter 2	1	HT <sub>7</sub>	HT <sub>6</sub>	HT <sub>5</sub>	HT <sub>4</sub>	HT <sub>3</sub>	HT <sub>2</sub>	HT <sub>1</sub>	HT <sub>0</sub>	xx
Parameter 3	1	0	0	0	0	0	HPS <sub>10</sub>	HPS <sub>9</sub>	HPS <sub>8</sub>	xx
Parameter 4	1	HPS <sub>7</sub>	HPS <sub>6</sub>	HPS <sub>5</sub>	HPS <sub>4</sub>	HPS <sub>3</sub>	HPS <sub>2</sub>	HPS <sub>1</sub>	HPS <sub>0</sub>	xx
Parameter 5	1	0	HPW <sub>6</sub>	HPW <sub>5</sub>	HPW <sub>4</sub>	HPW <sub>3</sub>	HPW <sub>2</sub>	HPW <sub>1</sub>	HPW <sub>0</sub>	xx
Parameter 6	1	0	0	0	0	0	LPS <sub>10</sub>	LPS <sub>9</sub>	LPS <sub>8</sub>	xx
Parameter 7	1	LPS <sub>7</sub>	LPS <sub>6</sub>	LPS <sub>5</sub>	LPS <sub>4</sub>	LPS <sub>3</sub>	LPS <sub>2</sub>	LPS <sub>1</sub>	LPS <sub>0</sub>	xx
Parameter 8	1	0	0	0	0	0	0	LPSPP <sub>1</sub>	LPSPP <sub>0</sub>	xx

#### Description

Get current front porch settings

HT[10:8] : High byte of the horizontal total period (display + non-display) in pixel clock (POR = 010)

HT[7:0] : Low byte of the horizontal total period (display + non-display) in pixel clock (POR = 10101111)

HPS[10:8] : High byte of the non-display period between the start of the horizontal sync (LLINE) signal and the first display data. (POR = 000)

HPS[7:0] : Low byte of the non-display period between the start of the horizontal sync (LLINE) signal and the first display data. (POR = 00100000)

HPW[6:0] : The horizontal sync pulse width (LLINE) in pixel clock. (POR = 000111)

LPS[10:8] : High byte of the horizontal sync pulse (LLINE) start location in pixel clock. (POR = 000)

LPS[7:0] : Low byte of the horizontal sync pulse width (LLINE) in start. (POR = 00000000)

LPSPP[1:0] : The horizontal sync pulse subpixel start position (POR = 00)

### 9.39 Set Vertical Period

**Command** B6h  
**Parameters** 7

	D/C	D7	D6	D5	D4	D3	D2	D1	D0	Hex
Command	0	1	0	1	1	0	1	1	0	B6
Parameter 1	1	0	0	0	0	0	VT <sub>10</sub>	VT <sub>9</sub>	VT <sub>8</sub>	xx
Parameter 2	1	VT <sub>7</sub>	VT <sub>6</sub>	VT <sub>5</sub>	VT <sub>4</sub>	VT <sub>3</sub>	VT <sub>2</sub>	VT <sub>1</sub>	VT <sub>0</sub>	xx
Parameter 3	1	0	0	0	0	0	VPS <sub>10</sub>	VPS <sub>9</sub>	VPS <sub>8</sub>	xx
Parameter 4	1	VPS <sub>7</sub>	VPS <sub>6</sub>	VPS <sub>5</sub>	VPS <sub>4</sub>	VPS <sub>3</sub>	VPS <sub>2</sub>	VPS <sub>1</sub>	VPS <sub>0</sub>	xx
Parameter 5	1	0	VPW <sub>6</sub>	VPW <sub>5</sub>	VPW <sub>4</sub>	VPW <sub>3</sub>	VPW <sub>2</sub>	VPW <sub>1</sub>	VPW <sub>0</sub>	xx
Parameter 6	1	0	0	0	0	0	FPS <sub>10</sub>	FPS <sub>9</sub>	FPS <sub>8</sub>	xx
Parameter 7	1	FPS <sub>7</sub>	FPS <sub>6</sub>	FPS <sub>5</sub>	FPS <sub>4</sub>	FPS <sub>3</sub>	FPS <sub>2</sub>	FPS <sub>1</sub>	FPS <sub>0</sub>	xx

#### Description

Set the vertical blanking interval between last scan line and next LFRAME pulse

VT[10:8] : High byte of the vertical total (display + non-display) period in lines (POR = 001)

VT[7:0] : Low byte of the vertical total (display + non-display) period in lines (POR = 11101111)  
 Vertical Total = (VT + 1) lines

VPS[10:8] : High byte the non-display period in lines between the start of the frame and the first display data in line. (POR = 000)

VPS[7:0] : The non-display period in lines between the start of the frame and the first display data in line. (POR = 00000100)  
 Vertical Sync Pulse Start Position = VPS lines

VPW[6:0] : Set the vertical sync pulse width (LFRAME) in lines. (POR = 000001)  
 Vertical Sync Pulse Width = (VPW + 1) lines

FPS[10:8] : High byte of the vertical sync pulse (LFRAME) start location in lines. (POR = 000)

FPS[7:0] : Low byte of the vertical sync pulse (LFRAME) start location in lines. (POR = 00000000)  
 Vertical Display Period Start Position = FPS lines

Timing refer to Figure 13-4.

### 9.40 Get Vertical Period

**Command** B7h  
**Parameters** 7

	D/C	D7	D6	D5	D4	D3	D2	D1	D0	Hex
Command	0	1	0	1	1	0	1	1	1	B7
Parameter 1	1	0	0	0	0	0	VT <sub>10</sub>	VT <sub>9</sub>	VT <sub>8</sub>	xx
Parameter 2	1	VT <sub>7</sub>	VT <sub>6</sub>	VT <sub>5</sub>	VT <sub>4</sub>	VT <sub>3</sub>	VT <sub>2</sub>	VT <sub>1</sub>	VT <sub>0</sub>	xx
Parameter 3	1	0	0	0	0	0	VPS <sub>10</sub>	VPS <sub>9</sub>	VPS <sub>8</sub>	xx
Parameter 4	1	VPS <sub>7</sub>	VPS <sub>6</sub>	VPS <sub>5</sub>	VPS <sub>4</sub>	VPS <sub>3</sub>	VPS <sub>2</sub>	VPS <sub>1</sub>	VPS <sub>0</sub>	xx
Parameter 5	1	0	VPW <sub>6</sub>	VPW <sub>5</sub>	VPW <sub>4</sub>	VPW <sub>3</sub>	VPW <sub>2</sub>	VPW <sub>1</sub>	VPW <sub>0</sub>	xx
Parameter 6	1	0	0	0	0	0	FPS <sub>10</sub>	FPS <sub>9</sub>	FPS <sub>8</sub>	xx
Parameter 7	1	FPS <sub>7</sub>	FPS <sub>6</sub>	FPS <sub>5</sub>	FPS <sub>4</sub>	FPS <sub>3</sub>	FPS <sub>2</sub>	FPS <sub>1</sub>	FPS <sub>0</sub>	xx

#### Description

Get the vertical blanking interval between last scan line and next LFRAME pulse



- VT[10:8] : High byte of the vertical total (display + non-display) period in lines (POR = 001)  
 VT[7:0] : Low byte of the vertical total (display + non-display) period in lines (POR = 01111111)
- VPS[10:8] : High byte of the non-display period in lines between the start of the frame and the first display data in line. (POR = 000)  
 VPS[7:0] : Low byte of the non-display period in lines between the start of the frame and the first display data in line. (POR = 00000100)
- VPW[6:0] : The vertical sync pulse width (LFRAME) in lines. (POR = 000001)
- FPS[10:8] : High byte of the vertical sync pulse (LFRAME) start location in lines. (POR = 000)  
 FPS[7:0] : Low byte of the vertical sync pulse (LFRAME) start location in lines. (POR = 00000000)

## 9.41 Set GPIO Configuration

**Command** B8h  
**Parameters** 2

	D/C	D7	D6	D5	D4	D3	D2	D1	D0	Hex
Command	0	1	0	1	1	1	0	0	0	B8
Parameter 1	1	A <sub>7</sub>	A <sub>6</sub>	A <sub>5</sub>	A <sub>4</sub>	A <sub>3</sub>	A <sub>2</sub>	A <sub>1</sub>	A <sub>0</sub>	xx
Parameter 2	1	0	0	0	0	0	0	0	B <sub>0</sub>	xx

### Description

Set the GPIOs configuration. If the GPIOs are not used for LCD, set the direction. Otherwise, they are toggled with LCD signals by 0xC0 – 0xCF.

- A[7] : GPIO3 configuration (POR = 0)  
 0 GPIO3 is controlled by host  
 1 GPIO3 is controlled by LCDC
- A[6] : GPIO2 configuration (POR = 0)  
 0 GPIO2 is controlled by host  
 1 GPIO2 is controlled by LCDC
- A[5] : GPIO1 configuration (POR = 0)  
 0 GPIO1 is controlled by host  
 1 GPIO1 is controlled by LCDC
- A[4] : GPIO0 configuration (POR = 0)  
 0 GPIO0 is controlled by host  
 1 GPIO0 is controlled by LCDC
- A[3] : GPIO3 direction (POR = 0)  
 0 GPIO3 is input  
 1 GPIO3 is output
- A[2] : GPIO2 direction (POR = 0)  
 0 GPIO2 is input  
 1 GPIO2 is output
- A[1] : GPIO1 direction (POR = 0)  
 0 GPIO1 is input  
 1 GPIO1 is output
- A[0] : GPIO0 direction (POR = 0)  
 0 GPIO0 is input  
 1 GPIO0 is output

B[0] : GPIO0 direction (POR = 0)  
 0 GPIO0 is used to control the panel power with Enter Sleep Mode 0x10 or Exit Sleep Mode 0x11.  
 1 GPIO0 is used as normal GPIO

## 9.42 Get GPIO Configuration

**Command** B9h  
**Parameters** 2

	D/C	D7	D6	D5	D4	D3	D2	D1	D0	Hex
Command	0	1	0	1	1	1	0	0	1	B9
Parameter 1	1	A <sub>7</sub>	A <sub>6</sub>	A <sub>5</sub>	A <sub>4</sub>	A <sub>3</sub>	A <sub>2</sub>	A <sub>1</sub>	A <sub>0</sub>	xx
Parameter 2	1	0	0	0	0	0	0	0	B <sub>0</sub>	xx

### Description

Get the current GPIOs configuration

A[7] : GPIO3 configuration (POR = 0)  
 0 GPIO3 is controlled by host  
 1 GPIO3 is controlled by LCDC

A[6] : GPIO2 configuration (POR = 0)  
 0 GPIO2 is controlled by host  
 1 GPIO2 is controlled by LCDC

A[5] : GPIO1 configuration (POR = 0)  
 0 GPIO1 is controlled by host  
 1 GPIO1 is controlled by LCDC

A[4] : GPIO0 configuration (POR = 0)  
 0 GPIO0 is controlled by host  
 1 GPIO0 is controlled by LCDC

A[3] : GPIO3 direction (POR = 0)  
 0 GPIO3 is input  
 1 GPIO3 is output

A[2] : GPIO2 direction (POR = 0)  
 0 GPIO2 is input  
 1 GPIO2 is output

A[1] : GPIO1 direction (POR = 0)  
 0 GPIO1 is input  
 1 GPIO1 is output

A[0] : GPIO0 direction (POR = 0)  
 0 GPIO0 is input  
 1 GPIO0 is output

B[0] : GPIO0 direction (POR = 0)  
 0 GPIO0 is used to control the panel power  
 1 GPIO0 is used as normal GPIO

### 9.43 Set GPIO Value

**Command**      BAh  
**Parameters**    1

	D/C	D7	D6	D5	D4	D3	D2	D1	D0	Hex
Command	0	1	0	1	1	1	0	1	0	BA
Parameter 1	1	0	0	0	0	A <sub>3</sub>	A <sub>2</sub>	A <sub>1</sub>	A <sub>0</sub>	xx

#### Description

Set GPIO value for GPIO configured as output

A[3] : GPIO3 value (POR = 0)  
 0      GPIO3 outputs 0  
 1      GPIO3 outputs 1

A[2] : GPIO2 value (POR = 0)  
 0      GPIO2 outputs 0  
 1      GPIO2 outputs 1

A[1] : GPIO1 value (POR = 0)  
 0      GPIO1 outputs 0  
 1      GPIO1 outputs 1

A[0] : GPIO0 value (POR = 0)  
 0      GPIO0 outputs 0  
 1      GPIO0 outputs 1

### 9.44 Get GPIO Value

**Command**      BBh  
**Parameters**    1

	D/C	D7	D6	D5	D4	D3	D2	D1	D0	Hex
Command	0	1	0	1	1	1	0	1	1	BB
Parameter 1	1	0	0	0	0	A <sub>3</sub>	A <sub>2</sub>	A <sub>1</sub>	A <sub>0</sub>	xx

#### Description

Read current GPIO status. If the individual GPIO was configured as input, the value is the status of the corresponding pin. Otherwise, it is the programmed value.

A[3] : GPIO3 value (POR : depends on pad value)  
 0      GPIO3 is pulled low  
 1      GPIO3 is pulled high

A[2] : GPIO2 value (POR : depends on pad value)  
 0      GPIO2 is pulled low  
 1      GPIO2 is pulled high

A[1] : GPIO1 value (POR : depends on pad value)  
 0      GPIO1 is pulled low  
 1      GPIO1 is pulled high

A[0] : GPIO0 value (POR : depends on pad value)  
 0      GPIO0 is pulled low  
 1      GPIO0 is pulled high

## 9.45 Set Post Proc

**Command** BCh  
**Parameters** 4

	D/C	D7	D6	D5	D4	D3	D2	D1	D0	Hex
Command	0	1	0	1	1	1	1	0	0	BC
Parameter 1	1	A <sub>7</sub>	A <sub>6</sub>	A <sub>5</sub>	A <sub>4</sub>	A <sub>3</sub>	A <sub>2</sub>	A <sub>1</sub>	A <sub>0</sub>	xx
Parameter 2	1	B <sub>7</sub>	B <sub>6</sub>	B <sub>5</sub>	B <sub>4</sub>	B <sub>3</sub>	B <sub>2</sub>	B <sub>1</sub>	B <sub>0</sub>	xx
Parameter 3	1	C <sub>7</sub>	C <sub>6</sub>	C <sub>5</sub>	C <sub>4</sub>	C <sub>3</sub>	C <sub>2</sub>	C <sub>1</sub>	C <sub>0</sub>	xx
Parameter 4	1	0	0	0	0	0	0	0	D <sub>0</sub>	xx

### Description

Set the image post processor

A[7:0] : Set the contrast value (POR = 01000000)

B[7:0] : Set the brightness value (POR = 10000000)

C[7:0] : Set the saturation value (POR = 01000000)

D[0] : Post Processor Enable (POR = 0)  
0 Disable the postprocessor  
1 Enable the postprocessor

## 9.46 Get Post Proc

**Command** BDh  
**Parameters** 4

	D/C	D7	D6	D5	D4	D3	D2	D1	D0	Hex
Command	0	1	0	1	1	1	1	0	1	BD
Parameter 1	1	A <sub>7</sub>	A <sub>6</sub>	A <sub>5</sub>	A <sub>4</sub>	A <sub>3</sub>	A <sub>2</sub>	A <sub>1</sub>	A <sub>0</sub>	xx
Parameter 2	1	B <sub>7</sub>	B <sub>6</sub>	B <sub>5</sub>	B <sub>4</sub>	B <sub>3</sub>	B <sub>2</sub>	B <sub>1</sub>	B <sub>0</sub>	xx
Parameter 3	1	C <sub>7</sub>	C <sub>6</sub>	C <sub>5</sub>	C <sub>4</sub>	C <sub>3</sub>	C <sub>2</sub>	C <sub>1</sub>	C <sub>0</sub>	xx
Parameter 4	1	0	0	0	0	0	0	0	D <sub>0</sub>	xx

### Description

Get the image post processor

A[7:0] : Get the contrast value (POR = 01000000)

B[7:0] : Get the brightness value (POR = 10000000)

C[7:0] : Get the saturation value (POR = 01000000)

D[0] : Post Processor Enable (POR = 0)  
0 Disable the postprocessor  
1 Enable the postprocessor

## 9.47 Set PWM Configuration

**Command** BEh  
**Parameters** 6

	D/C	D7	D6	D5	D4	D3	D2	D1	D0	Hex
Command	0	1	0	1	1	1	1	1	0	BE
Parameter 1	1	PWMF <sub>7</sub>	PWMF <sub>6</sub>	PWMF <sub>5</sub>	PWMF <sub>4</sub>	PWMF <sub>3</sub>	PWMF <sub>2</sub>	PWMF <sub>1</sub>	PWMF <sub>0</sub>	xx
Parameter 2	1	PWM <sub>7</sub>	PWM <sub>6</sub>	PWM <sub>5</sub>	PWM <sub>4</sub>	PWM <sub>3</sub>	PWM <sub>2</sub>	PWM <sub>1</sub>	PWM <sub>0</sub>	xx
Parameter 3	1	0	0	0	0	C <sub>3</sub>	0	0	C <sub>0</sub>	xx
Parameter 4	1	D <sub>7</sub>	D <sub>6</sub>	D <sub>5</sub>	D <sub>4</sub>	D <sub>3</sub>	D <sub>2</sub>	D <sub>1</sub>	D <sub>0</sub>	xx
Parameter 5	1	E <sub>7</sub>	E <sub>6</sub>	E <sub>5</sub>	E <sub>4</sub>	E <sub>3</sub>	E <sub>2</sub>	E <sub>1</sub>	E <sub>0</sub>	xx
Parameter 6	1	0	0	0	0	F <sub>3</sub>	F <sub>2</sub>	F <sub>1</sub>	F <sub>0</sub>	xx

### Description

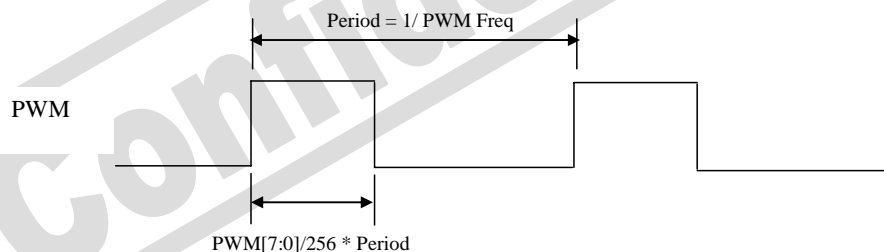
Set the PWM configuration

PWMF[7:0] : Set the PWM frequency in system clock (POR = 00000000)  
 PWM signal frequency = PLL clock / (256 \* PWMF[7:0]) / 256

PWM[7:0] : Set the PWM duty cycle (POR = 00000000)  
 PWM duty cycle = PWM[7:0] / 256

Note : PWM always 0 if PWM[7:0] = 00h

**Figure 9-19: PWM signal**



C[3] : PWM configuration (POR = 0)

0 PWM controlled by host  
 1 PWM controlled by DBC

C[0] : PWM enable (POR = 0)

0 PWM disable  
 1 PWM enable

D[7:0] : DBC manual brightness (POR = 00000000)

Set the brightness level

00 Dimmest  
 FF brightest

E[7:0] : DBC minimum brightness (POR = 00000000)

Set the minimum brightness level

00 Dimmest  
 FF Brightest

F[3:0] : Brightness prescaler (POR = 0000)

Set the brightness prescaler

0 Dimmest  
 F Brightest

## 9.48 Get PWM Configuration

**Command**       BFh  
**Parameters**     7

	D/C	D7	D6	D5	D4	D3	D2	D1	D0	Hex
Command	0	1	0	1	1	1	1	1	1	BF
Parameter 1	1	PWMF <sub>7</sub>	PWMF <sub>6</sub>	PWMF <sub>5</sub>	PWMF <sub>4</sub>	PWMF <sub>3</sub>	PWMF <sub>2</sub>	PWMF <sub>1</sub>	PWMF <sub>0</sub>	xx
Parameter 2	1	PWM <sub>7</sub>	PWM <sub>6</sub>	PWM <sub>5</sub>	PWM <sub>4</sub>	PWM <sub>3</sub>	PWM <sub>2</sub>	PWM <sub>1</sub>	PWM <sub>0</sub>	xx
Parameter 3	1	0	0	0	0	C <sub>3</sub>	0	0	C <sub>0</sub>	xx
Parameter 4	1	D <sub>7</sub>	D <sub>6</sub>	D <sub>5</sub>	D <sub>4</sub>	D <sub>3</sub>	D <sub>2</sub>	D <sub>1</sub>	D <sub>0</sub>	xx
Parameter 5	1	E <sub>7</sub>	E <sub>6</sub>	E <sub>5</sub>	E <sub>4</sub>	E <sub>3</sub>	E <sub>2</sub>	E <sub>1</sub>	E <sub>0</sub>	xx
Parameter 6	1	0	0	0	0	F <sub>3</sub>	F <sub>2</sub>	F <sub>1</sub>	F <sub>0</sub>	xx
Parameter 7	1	G <sub>7</sub>	G <sub>6</sub>	G <sub>5</sub>	G <sub>4</sub>	G <sub>3</sub>	G <sub>2</sub>	G <sub>1</sub>	G <sub>0</sub>	xx

### Description

Get the PWM configuration

PWMF[7:0] : Get the PWM frequency in system clock (POR = 00000000)

PWM[7:0] : Get the PWM duty cycle (POR = 00000000)

C[3] : PWM configuration (POR = 0)

0       PWM controlled by host  
 1       PWM controlled by DBC

C[0] : PWM enable (POR = 0)

0       PWM disable  
 1       PWM enable

D[7:0] : DBC manual brightness (POR = 00000000)

Set the brightness level

00       Dimmest  
 FF       brightest

When Manual Brightness Mode (0xD0 A[6]) is enabled, the final DBC duty cycle output will be multiplied by this Manual Brightness value / 255.

E[7:0] : DBC minimum brightness (POR = 00000000)

Set the minimum brightness level. DBC duty cycle output will be limited by this value. This will prevent from backlight being too dark or off.

00       Dimmest  
 FF       Brightest

F[3:0] : Brightness prescaler (POR = 0000)

Set the brightness prescaler

0       Dimmest  
 F       Brightest

This field is valid when Transition Effect (0xD0 A[5]) is on.

G[7:0] : Dynamic backlight duty cycle : Get the current PWM duty cycle controlled by PWM (POR = 00000000)

## 9.49 Set LCD Gen0

**Command** C0h  
**Parameters** 7

	D/C	D7	D6	D5	D4	D3	D2	D1	D0	Hex
Command	0	1	1	0	0	0	0	0	0	C0
Parameter 1	1	A <sub>7</sub>	0	0	0	0	0	0	0	xx
Parameter 2	1	0	0	0	0	0	GF0 <sub>2</sub>	GF0 <sub>1</sub>	GF0 <sub>0</sub>	xx
Parameter 3	1	GF0 <sub>7</sub>	GF0 <sub>6</sub>	GF0 <sub>5</sub>	GF0 <sub>4</sub>	GF0 <sub>3</sub>	GF0 <sub>2</sub>	GF0 <sub>1</sub>	GF0 <sub>0</sub>	xx
Parameter 4	1	0	0	0	0	0	GR0 <sub>2</sub>	GR0 <sub>1</sub>	GR0 <sub>0</sub>	xx
Parameter 5	1	GR0 <sub>7</sub>	GR0 <sub>6</sub>	GR0 <sub>5</sub>	GR0 <sub>4</sub>	GR0 <sub>3</sub>	GR0 <sub>2</sub>	GR0 <sub>1</sub>	GR0 <sub>0</sub>	xx
Parameter 6	1	F <sub>7</sub>	F <sub>6</sub>	F <sub>5</sub>	F <sub>4</sub>	F <sub>3</sub>	GP0 <sub>2</sub>	GP0 <sub>1</sub>	GP0 <sub>0</sub>	xx
Parameter 7	1	GP0 <sub>7</sub>	GP0 <sub>6</sub>	GP0 <sub>5</sub>	GP0 <sub>4</sub>	GP0 <sub>3</sub>	GP0 <sub>2</sub>	GP0 <sub>1</sub>	GP0 <sub>0</sub>	xx

### Description

Set the rise, fall, period and toggling properties of LCD signal generator 0

A[7] : Reset LCD generator 0 at every frame start

- 0 The generator 0 will not reset in the starting point of a frame
- 1 The generator 0 will reset in the starting point of a frame

GF0[10:8] : The highest 3 bits of the generator 0 falling position (POR = 000)

GF0[7:0] : The lower byte of the generator 0 falling position (POR = 00000001)

GR0[10:8] : The highest 3 bits of the generator 0 rising position (POR = 000)

GR0[7:0] : The lower byte of the generator 0 rising position (POR = 00000000)

F[7] : Force the generator 0 output to 0 in non-display period

- 0 generator 0 is normal
- 1 generator 0 output is forced to zero in non-display period

F[6:5] : Force the generator 0 output to 0 in odd or even lines

- 00 generator 0 is normal in both odd and even lines
- 01 generator 0 output is force to 0 in odd lines
- 10 generator 0 output is force to 0 in even lines
- 11 generator 0 is normal in both odd and even line

F[4:3] : Generator 0 toggle mode

- 00 Disable
- 01 Toggle by pixel clock (LSHIFT)
- 10 Toggle by Line (LLINE)
- 11 Toggle by Frame (LFRAME)

GP0[10:8] : The highest 3 bits of the generator 0 period (POR = 100)

GP0[7:0] : The lower byte of the generator 0 period (POR = 00000000)

## 9.50 Get LCD Gen0

**Command** C1h  
**Parameters** 7

	D/C	D7	D6	D5	D4	D3	D2	D1	D0	Hex
Command	0	1	1	0	0	0	0	0	1	C1
Parameter 1	1	A <sub>7</sub>	0	0	0	0	0	0	0	xx
Parameter 2	1	0	0	0	0	0	GF0 <sub>2</sub>	GF0 <sub>1</sub>	GF0 <sub>0</sub>	xx
Parameter 3	1	GF0 <sub>7</sub>	GF0 <sub>6</sub>	GF0 <sub>5</sub>	GF0 <sub>4</sub>	GF0 <sub>3</sub>	GF0 <sub>2</sub>	GF0 <sub>1</sub>	GF0 <sub>0</sub>	xx
Parameter 4	1	0	0	0	0	0	GR0 <sub>2</sub>	GR0 <sub>1</sub>	GR0 <sub>0</sub>	xx
Parameter 5	1	GR0 <sub>7</sub>	GR0 <sub>6</sub>	GR0 <sub>5</sub>	GR0 <sub>4</sub>	GR0 <sub>3</sub>	GR0 <sub>2</sub>	GR0 <sub>1</sub>	GR0 <sub>0</sub>	xx
Parameter 6	1	F <sub>7</sub>	F <sub>6</sub>	F <sub>5</sub>	F <sub>4</sub>	F <sub>3</sub>	GP0 <sub>2</sub>	GP0 <sub>1</sub>	GP0 <sub>0</sub>	xx
Parameter 7	1	GP0 <sub>7</sub>	GP0 <sub>6</sub>	GP0 <sub>5</sub>	GP0 <sub>4</sub>	GP0 <sub>3</sub>	GP0 <sub>2</sub>	GP0 <sub>1</sub>	GP0 <sub>0</sub>	xx

### Description

Get the rise, fall, period and toggling properties of LCD signal generator 0

A[7] : Reset LCD generator 0 at every frame start

- 0 The generator 0 will not reset in the starting point of a frame
- 1 The generator 0 will reset in the starting point of a frame

GF0[10:8] : The highest 3 bits of the generator 0 falling position (POR = 000)

GF0[7:0] : The lower byte of the generator 0 falling position (POR = 00000001)

GR0[10:8] : The highest 3 bits of the generator 0 rising position (POR = 000)

GR0[7:0] : The lower byte of the generator 0 rising position (POR = 00000000)

F[7] : Force the generator 0 output to 0 in non-display period

- 0 generator 0 is normal
- 1 generator 0 output is forced to zero in non-display period

F[6:5] : Force the generator 0 output to 0 in odd or even lines

- 00 generator 0 is normal in both odd and even lines
- 01 generator 0 output is force to 0 in odd lines
- 10 generator 0 output is force to 0 in even lines
- 11 generator 0 is normal in both odd and even line

F[4:3] : Generator 0 toggle mode

- 00 Disable
- 01 Toggle by pixel clock (LSHIFT)
- 10 Toggle by Line (LLINE)
- 11 Toggle by Frame (LFRAME)

GP0[10:8] : The highest 3 bits of the generator 0 period (POR = 100)

GP0[7:0] : The lower byte of the generator 0 period (POR = 00000000)



## 9.51 Set LCD Gen1

**Command** C2h  
**Parameters** 7

	D/C	D7	D6	D5	D4	D3	D2	D1	D0	Hex
Command	0	1	1	0	0	0	0	1	0	C2
Parameter 1	1	A <sub>7</sub>	0	0	0	0	0	0	0	xx
Parameter 2	1	0	0	0	0	0	GF1 <sub>2</sub>	GF1 <sub>1</sub>	GF1 <sub>0</sub>	xx
Parameter 3	1	GF1 <sub>7</sub>	GF1 <sub>6</sub>	GF1 <sub>5</sub>	GF1 <sub>4</sub>	GF1 <sub>3</sub>	GF1 <sub>2</sub>	GF1 <sub>1</sub>	GF1 <sub>0</sub>	xx
Parameter 4	1	0	0	0	0	0	GR1 <sub>2</sub>	GR1 <sub>1</sub>	GR1 <sub>0</sub>	xx
Parameter 5	1	GR1 <sub>7</sub>	GR1 <sub>6</sub>	GR1 <sub>5</sub>	GR1 <sub>4</sub>	GR1 <sub>3</sub>	GR1 <sub>2</sub>	GR1 <sub>1</sub>	GR1 <sub>0</sub>	xx
Parameter 6	1	F <sub>7</sub>	F <sub>6</sub>	F <sub>5</sub>	F <sub>4</sub>	F <sub>3</sub>	GP1 <sub>2</sub>	GP1 <sub>1</sub>	GP1 <sub>0</sub>	xx
Parameter 7	1	GP1 <sub>7</sub>	GP1 <sub>6</sub>	GP1 <sub>5</sub>	GP1 <sub>4</sub>	GP1 <sub>3</sub>	GP1 <sub>2</sub>	GP1 <sub>1</sub>	GP1 <sub>0</sub>	xx

### Description

Set the rise, fall, period and toggling properties of LCD signal generator 1

A[7] : Reset LCD generator 1 at every frame start

- 0 The generator 1 will not reset in the starting point of a frame
- 1 The generator 1 will reset in the starting point of a frame

GF1[10:8] : The highest 3 bits of the generator 1 falling position (POR = 000)

GF1[7:0] : The lower byte of the generator 1 falling position (POR = 00000001)

GR1[10:8] : The highest 3 bits of the generator 1 rising position (POR = 000)

GR1[7:0] : The lower byte of the generator 1 rising position (POR = 00000000)

F[7] : Force the generator 1 output to 0 in non-display period

- 0 generator 1 is normal
- 1 generator 1 output is forced to zero in non-display period

F[6:5] : Force the generator 1 output to 0 in odd or even lines

- 00 generator 1 is normal in both odd and even lines
- 01 generator 1 output is force to 0 in odd lines
- 10 generator 1 output is force to 0 in even lines
- 11 generator 1 is normal in both odd and even line

F[4:3] : Generator 1 toggle mode

- 00 Disable
- 01 Toggle by pixel clock (LSHIFT)
- 10 Toggle by Line (LLINE)
- 11 Toggle by Frame (LFRAME)

GP1[10:8] : The highest 3 bits of the generator 1 period (POR = 100)

GP1[7:0] : The lower byte of the generator 1 period (POR = 00000000)

## 9.52 Get LCD Gen1

**Command** C3h  
**Parameters** 7

	D/C	D7	D6	D5	D4	D3	D2	D1	D0	Hex
Command	0	1	1	0	0	0	0	1	1	C3
Parameter 1	1	A <sub>7</sub>	0	0	0	0	0	0	0	xx
Parameter 2	1	0	0	0	0	0	GF1 <sub>2</sub>	GF1 <sub>1</sub>	GF1 <sub>0</sub>	xx
Parameter 3	1	GF1 <sub>7</sub>	GF1 <sub>6</sub>	GF1 <sub>5</sub>	GF1 <sub>4</sub>	GF1 <sub>3</sub>	GF1 <sub>2</sub>	GF1 <sub>1</sub>	GF1 <sub>0</sub>	xx
Parameter 4	1	0	0	0	0	0	GR1 <sub>2</sub>	GR1 <sub>1</sub>	GR1 <sub>0</sub>	xx
Parameter 5	1	GR1 <sub>7</sub>	GR1 <sub>6</sub>	GR1 <sub>5</sub>	GR1 <sub>4</sub>	GR1 <sub>3</sub>	GR1 <sub>2</sub>	GR1 <sub>1</sub>	GR1 <sub>0</sub>	xx
Parameter 6	1	F <sub>7</sub>	F <sub>6</sub>	F <sub>5</sub>	F <sub>4</sub>	F <sub>3</sub>	GP1 <sub>2</sub>	GP1 <sub>1</sub>	GP1 <sub>0</sub>	xx
Parameter 7	1	GP1 <sub>7</sub>	GP1 <sub>6</sub>	GP1 <sub>5</sub>	GP1 <sub>4</sub>	GP1 <sub>3</sub>	GP1 <sub>2</sub>	GP1 <sub>1</sub>	GP1 <sub>0</sub>	xx

### Description

Get the rise, fall, period and toggling properties of LCD signal generator 1

A[7] : Reset LCD generator 1 at every frame start

- 0 The generator 1 will not reset in the starting point of a frame
- 1 The generator 1 will reset in the starting point of a frame

GF1[10:8] : The highest 3 bits of the generator 1 falling position (POR = 000)

GF1[7:0] : The lower byte of the generator 1 falling position (POR = 00000001)

GR1[10:8] : The highest 3 bits of the generator 1 rising position (POR = 000)

GR1[7:0] : The lower byte of the generator 1 rising position (POR = 00000000)

F[7] : Force the generator 1 output to 0 in non-display period

- 0 generator 1 is normal
- 1 generator 1 output is forced to zero in non-display period

F[6:5] : Force the generator 1 output to 0 in odd or even lines

- 00 generator 1 is normal in both odd and even lines
- 01 generator 1 output is force to 0 in odd lines
- 10 generator 1 output is force to 0 in even lines
- 11 generator 1 is normal in both odd and even line

F[4:3] : Generator 1 toggle mode

- 00 Disable
- 01 Toggle by pixel clock (LSHIFT)
- 10 Toggle by Line (LLINE)
- 11 Toggle by Frame (LFRAME)

GP1[10:8] : The highest 3 bits of the generator 1 period (POR = 100)

GP1[7:0] : The lower byte of the generator 1 period (POR = 00000000)

## 9.53 Set LCD Gen2

**Command** C4h  
**Parameters** 7

	D/C	D7	D6	D5	D4	D3	D2	D1	D0	Hex
Command	0	1	1	0	0	0	1	0	0	C4
Parameter 1	1	A <sub>7</sub>	0	0	0	0	0	0	0	xx
Parameter 2	1	0	0	0	0	0	GF2 <sub>2</sub>	GF2 <sub>1</sub>	GF2 <sub>0</sub>	xx
Parameter 3	1	GF2 <sub>7</sub>	GF2 <sub>6</sub>	GF2 <sub>5</sub>	GF2 <sub>4</sub>	GF2 <sub>3</sub>	GF2 <sub>2</sub>	GF2 <sub>1</sub>	GF2 <sub>0</sub>	xx
Parameter 4	1	0	0	0	0	0	GR2 <sub>2</sub>	GR2 <sub>1</sub>	GR2 <sub>0</sub>	xx
Parameter 5	1	GR2 <sub>7</sub>	GR2 <sub>6</sub>	GR2 <sub>5</sub>	GR2 <sub>4</sub>	GR2 <sub>3</sub>	GR2 <sub>2</sub>	GR2 <sub>1</sub>	GR2 <sub>0</sub>	xx
Parameter 6	1	F <sub>7</sub>	F <sub>6</sub>	F <sub>5</sub>	F <sub>4</sub>	F <sub>3</sub>	GP2 <sub>2</sub>	GP2 <sub>1</sub>	GP2 <sub>0</sub>	xx
Parameter 7	1	GP2 <sub>7</sub>	GP2 <sub>6</sub>	GP2 <sub>5</sub>	GP2 <sub>4</sub>	GP2 <sub>3</sub>	GP2 <sub>2</sub>	GP2 <sub>1</sub>	GP2 <sub>0</sub>	xx

### Description

Set the rise, fall, period and toggling properties of LCD signal generator 2

A[7] : Reset LCD generator 2 at every frame start

- 0 The generator 2 will not reset in the starting point of a frame
- 1 The generator 2 will reset in the starting point of a frame

GF2[10:8] : The highest 3 bits of the generator 2 falling position (POR = 000)

GF2[7:0] : The lower byte of the generator 2 falling position (POR = 00000001)

GR2[10:8] : The highest 3 bits of the generator 2 rising position (POR = 000)

GR2[7:0] : The lower byte of the generator 2 rising position (POR = 00000000)

F[7] : Force the generator 2 output to 0 in non-display period

- 0 generator 2 is normal
- 1 generator 2 output is forced to zero in non-display period

F[6:5] : Force the generator 2 output to 0 in odd or even lines

- 00 generator 2 is normal in both odd and even lines
- 01 generator 2 output is force to 0 in odd lines
- 10 generator 2 output is force to 0 in even lines
- 11 generator 2 is normal in both odd and even line

F[4:3] : Generator 2 toggle mode

- 00 Disable
- 01 Toggle by pixel clock (LSHIFT)
- 10 Toggle by Line (LLINE)
- 11 Toggle by Frame (LFRAME)

GP2[10:8] : The highest 3 bits of the generator 2 period (POR = 100)

GP2[7:0] : The lower byte of the generator 2 period (POR = 00000000)

## 9.54 Get LCD Gen2

**Command** C5h  
**Parameters** 7

	D/C	D7	D6	D5	D4	D3	D2	D1	D0	Hex
Command	0	1	1	0	0	0	1	0	1	C5
Parameter 1	1	A <sub>7</sub>	0	0	0	0	0	0	0	xx
Parameter 2	1	0	0	0	0	0	GF2 <sub>2</sub>	GF2 <sub>1</sub>	GF2 <sub>0</sub>	xx
Parameter 3	1	GF2 <sub>7</sub>	GF2 <sub>6</sub>	GF2 <sub>5</sub>	GF2 <sub>4</sub>	GF2 <sub>3</sub>	GF2 <sub>2</sub>	GF2 <sub>1</sub>	GF2 <sub>0</sub>	xx
Parameter 4	1	0	0	0	0	0	GR2 <sub>2</sub>	GR2 <sub>1</sub>	GR2 <sub>0</sub>	xx
Parameter 5	1	GR2 <sub>7</sub>	GR2 <sub>6</sub>	GR2 <sub>5</sub>	GR2 <sub>4</sub>	GR2 <sub>3</sub>	GR2 <sub>2</sub>	GR2 <sub>1</sub>	GR2 <sub>0</sub>	xx
Parameter 6	1	F <sub>7</sub>	F <sub>6</sub>	F <sub>5</sub>	F <sub>4</sub>	F <sub>3</sub>	GP2 <sub>2</sub>	GP2 <sub>1</sub>	GP2 <sub>0</sub>	xx
Parameter 7	1	GP2 <sub>7</sub>	GP2 <sub>6</sub>	GP2 <sub>5</sub>	GP2 <sub>4</sub>	GP2 <sub>3</sub>	GP2 <sub>2</sub>	GP2 <sub>1</sub>	GP2 <sub>0</sub>	xx

### Description

Get the rise, fall, period and toggling properties of LCD signal generator 2

A[7] : Reset LCD generator 2 at every frame start

- 0 The generator 2 will not reset in the starting point of a frame
- 1 The generator 2 will reset in the starting point of a frame

GF2[10:8] : The highest 3 bits of the generator 2 falling position (POR = 000)

GF2[7:0] : The lower byte of the generator 2 falling position (POR = 00000001)

GR2[10:8] : The highest 3 bits of the generator 2 rising position (POR = 000)

GR2[7:0] : The lower byte of the generator 2 rising position (POR = 00000000)

F[7] : Force the generator 2 output to 0 in non-display period

- 0 generator 2 is normal
- 1 generator 2 output is forced to zero in non-display period

F[6:5] : Force the generator 2 output to 0 in odd or even lines

- 00 generator 2 is normal in both odd and even lines
- 01 generator 2 output is force to 0 in odd lines
- 10 generator 2 output is force to 0 in even lines
- 11 generator 2 is normal in both odd and even line

F[4:3] : Generator 2 toggle mode

- 00 Disable
- 01 Toggle by pixel clock (LSHIFT)
- 10 Toggle by Line (LLINE)
- 11 Toggle by Frame (LFRAME)

GP2[10:8] : The highest 3 bits of the generator 2 period (POR = 100)

GP2[7:0] : The lower byte of the generator 2 period (POR = 00000000)

## 9.55 Set LCD Gen3

**Command** C6h  
**Parameters** 7

	D/C	D7	D6	D5	D4	D3	D2	D1	D0	Hex
Command	0	1	1	0	0	0	1	1	0	C6
Parameter 1	1	A <sub>7</sub>	0	0	0	0	0	0	0	xx
Parameter 2	1	0	0	0	0	0	GF3 <sub>2</sub>	GF3 <sub>1</sub>	GF3 <sub>0</sub>	xx
Parameter 3	1	GF3 <sub>7</sub>	GF3 <sub>6</sub>	GF3 <sub>5</sub>	GF3 <sub>4</sub>	GF3 <sub>3</sub>	GF3 <sub>2</sub>	GF3 <sub>1</sub>	GF3 <sub>0</sub>	xx
Parameter 4	1	0	0	0	0	0	GR3 <sub>2</sub>	GR3 <sub>1</sub>	GR3 <sub>0</sub>	xx
Parameter 5	1	GR3 <sub>7</sub>	GR3 <sub>6</sub>	GR3 <sub>5</sub>	GR3 <sub>4</sub>	GR3 <sub>3</sub>	GR3 <sub>2</sub>	GR3 <sub>1</sub>	GR3 <sub>0</sub>	xx
Parameter 6	1	F <sub>7</sub>	F <sub>6</sub>	F <sub>5</sub>	F <sub>4</sub>	F <sub>3</sub>	GP3 <sub>2</sub>	GP3 <sub>1</sub>	GP3 <sub>0</sub>	xx
Parameter 7	1	GP3 <sub>7</sub>	GP3 <sub>6</sub>	GP3 <sub>5</sub>	GP3 <sub>4</sub>	GP3 <sub>3</sub>	GP3 <sub>2</sub>	GP3 <sub>1</sub>	GP3 <sub>0</sub>	xx

### Description

Set the rise, fall, period and toggling properties of LCD signal generator 3

A[7] : Reset LCD generator 3 at every frame start

- 0 The generator 3 will not reset in the starting point of a frame
- 1 The generator 3 will reset in the starting point of a frame

GF3[10:8] : The highest 3 bits of the generator 3 falling position (POR = 000)

GF3[7:0] : The lower byte of the generator 3 falling position (POR = 00000001)

GR3[10:8] : The highest 3 bits of the generator 3 rising position (POR = 000)

GR3[7:0] : The lower byte of the generator 3 rising position (POR = 00000000)

F[7] : Force the generator 3 output to 0 in non-display period

- 0 generator 3 is normal
- 1 generator 3 output is forced to zero in non-display period

F[6:5] : Force the generator 3 output to 0 in odd or even lines

- 00 generator 3 is normal in both odd and even lines
- 01 generator 3 output is force to 0 in odd lines
- 10 generator 3 output is force to 0 in even lines
- 11 generator 3 is normal in both odd and even line

F[4:3] : Generator 3 toggle mode

- 00 Disable
- 01 Toggle by pixel clock (LSHIFT)
- 10 Toggle by Line (LLINE)
- 11 Toggle by Frame (LFRAME)

GP3[10:8] : The highest 3 bits of the generator 3 period (POR = 100)

GP3[7:0] : The lower byte of the generator 3 period (POR = 00000000)

## 9.56 Get LCD Gen3

**Command** C7h  
**Parameters** 7

	D/C	D7	D6	D5	D4	D3	D2	D1	D0	Hex
Command	0	1	1	0	0	0	1	1	1	C7
Parameter 1	1	A <sub>7</sub>	0	0	0	0	0	0	0	xx
Parameter 2	1	0	0	0	0	0	GF3 <sub>2</sub>	GF3 <sub>1</sub>	GF3 <sub>0</sub>	xx
Parameter 3	1	GF3 <sub>7</sub>	GF3 <sub>6</sub>	GF3 <sub>5</sub>	GF3 <sub>4</sub>	GF3 <sub>3</sub>	GF3 <sub>2</sub>	GF3 <sub>1</sub>	GF3 <sub>0</sub>	xx
Parameter 4	1	0	0	0	0	0	GR3 <sub>2</sub>	GR3 <sub>1</sub>	GR3 <sub>0</sub>	xx
Parameter 5	1	GR3 <sub>7</sub>	GR3 <sub>6</sub>	GR3 <sub>5</sub>	GR3 <sub>4</sub>	GR3 <sub>3</sub>	GR3 <sub>2</sub>	GR3 <sub>1</sub>	GR3 <sub>0</sub>	xx
Parameter 6	1	F <sub>7</sub>	F <sub>6</sub>	F <sub>5</sub>	F <sub>4</sub>	F <sub>3</sub>	GP3 <sub>2</sub>	GP3 <sub>1</sub>	GP3 <sub>0</sub>	xx
Parameter 7	1	GP3 <sub>7</sub>	GP3 <sub>6</sub>	GP3 <sub>5</sub>	GP3 <sub>4</sub>	GP3 <sub>3</sub>	GP3 <sub>2</sub>	GP3 <sub>1</sub>	GP3 <sub>0</sub>	xx

### Description

Get the rise, fall, period and toggling properties of LCD signal generator 3

A[7] : Reset LCD generator 3 at every frame start

- 0 The generator 3 will not reset in the starting point of a frame
- 1 The generator 3 will reset in the starting point of a frame

GF3[10:8] : The highest 3 bits of the generator 3 falling position (POR = 000)

GF3[7:0] : The lower byte of the generator 3 falling position (POR = 00000001)

GR3[10:8] : The highest 3 bits of the generator 3 rising position (POR = 000)

GR3[7:0] : The lower byte of the generator 3 rising position (POR = 00000000)

F[7] : Force the generator 3 output to 0 in non-display period

- 0 generator 3 is normal
- 1 generator 3 output is forced to zero in non-display period

F[6:5] : Force the generator 3 output to 0 in odd or even lines

- 00 generator 3 is normal in both odd and even lines
- 01 generator 3 output is force to 0 in odd lines
- 10 generator 3 output is force to 0 in even lines
- 11 generator 3 is normal in both odd and even line

F[4:3] : Generator 3 toggle mode

- 00 Disable
- 01 Toggle by pixel clock (LSHIFT)
- 10 Toggle by Line (LLINE)
- 11 Toggle by Frame (LFRAME)

GP3[10:8] : The highest 3 bits of the generator 3 period (POR = 100)

GP3[7:0] : The lower byte of the generator 3 period (POR = 00000000)

## 9.57 Set GPIO0 ROP

**Command** C8h  
**Parameters** 2

	D/C	D7	D6	D5	D4	D3	D2	D1	D0	Hex
Command	0	1	1	0	0	1	0	0	0	C8
Parameter 1	1	0	A <sub>6</sub>	A <sub>5</sub>	0	A <sub>3</sub>	A <sub>2</sub>	A <sub>1</sub>	A <sub>0</sub>	xx
Parameter 2	1	B <sub>7</sub>	B <sub>6</sub>	B <sub>5</sub>	B <sub>4</sub>	B <sub>3</sub>	B <sub>2</sub>	B <sub>1</sub>	B <sub>0</sub>	xx

### Description

Set the GPIO0 with respect to the LCD signal generators using ROP3 operation. No effect if the GPIO0 is configured as general GPIO.

A[6:5] : Source 1 for GPIO0 when controlled by LCDC (POR = 00)

00 Generator 0  
 01 Generator 1  
 10 Generator 2  
 11 Generator 3

A[3:2] : Source 2 for GPIO0 when controlled by LCDC (POR = 00)

00 Generator 0  
 01 Generator 1  
 10 Generator 2  
 11 Generator 3

A[1:0] : Source 3 for GPIO0 when controlled by LCDC (POR = 00)

00 Generator 0  
 01 Generator 1  
 10 Generator 2  
 11 Generator 3

B[7:0] : ROP3 operation between source 1, 2 and 3 for GPIO0 (POR = 00000000)

Please refer to the ROP3 operation table

## 9.58 Get GPIO0 ROP

**Command** C9h  
**Parameters** 2

	D/C	D7	D6	D5	D4	D3	D2	D1	D0	Hex
Command	0	1	1	0	0	1	0	0	1	C9
Parameter 1	1	0	A <sub>6</sub>	A <sub>5</sub>	0	A <sub>3</sub>	A <sub>2</sub>	A <sub>1</sub>	A <sub>0</sub>	xx
Parameter 2	1	B <sub>7</sub>	B <sub>6</sub>	B <sub>5</sub>	B <sub>4</sub>	B <sub>3</sub>	B <sub>2</sub>	B <sub>1</sub>	B <sub>0</sub>	xx

### Description

Get the GPIO0 properties with respect to the LCD signal generators.

A[6:5] : Source 1 for GPIO0 when controlled by LCDC (POR = 00)

00 Generator 0  
 01 Generator 1  
 10 Generator 2  
 11 Generator 3

A[3:2] : Source 2 for GPIO0 when controlled by LCDC (POR = 00)  
 00 Generator 0  
 01 Generator 1  
 10 Generator 2  
 11 Generator 3

A[1:0] : Source 3 for GPIO0 when controlled by LCDC (POR = 00)  
 00 Generator 0  
 01 Generator 1  
 10 Generator 2  
 11 Generator 3

B[7:0] : ROP3 operation between source 1, 2 and 3 for GPIO0 (POR = 00000000)  
 Please refer to the ROP3 operation table

## 9.59 Set GPIO1 ROP

**Command** CAh  
**Parameters** 2

	D/C	D7	D6	D5	D4	D3	D2	D1	D0	Hex
Command	0	1	1	0	0	1	0	1	0	CA
Parameter 1	1	0	A <sub>6</sub>	A <sub>5</sub>	0	A <sub>3</sub>	A <sub>2</sub>	A <sub>1</sub>	A <sub>0</sub>	xx
Parameter 2	1	B <sub>7</sub>	B <sub>6</sub>	B <sub>5</sub>	B <sub>4</sub>	B <sub>3</sub>	B <sub>2</sub>	B <sub>1</sub>	B <sub>0</sub>	xx

### Description

Set the GPIO1 with respect to the LCD signal generators using ROP3 operation. No effect if the GPIO1 is configured as general GPIO.

A[6:5] : Source 1 for GPIO1 when controlled by LCDC (POR = 00)  
 00 Generator 0  
 01 Generator 1  
 10 Generator 2  
 11 Generator 3

A[3:2] : Source 2 for GPIO1 when controlled by LCDC (POR = 00)  
 00 Generator 0  
 01 Generator 1  
 10 Generator 2  
 11 Generator 3

A[1:0] : Source 3 for GPIO1 when controlled by LCDC (POR = 00)  
 00 Generator 0  
 01 Generator 1  
 10 Generator 2  
 11 Generator 3

B[7:0] : ROP3 operation between source 1, 2 and 3 for GPIO1 (POR = 00000000)  
 Please refer to the ROP3 operation table



## 9.60 Get GPIO1 ROP

**Command** CBh  
**Parameters** 2

	D/C	D7	D6	D5	D4	D3	D2	D1	D0	Hex
Command	0	1	1	0	0	1	0	1	1	CB
Parameter 1	1	0	A <sub>6</sub>	A <sub>5</sub>	0	A <sub>3</sub>	A <sub>2</sub>	A <sub>1</sub>	A <sub>0</sub>	xx
Parameter 2	1	B <sub>7</sub>	B <sub>6</sub>	B <sub>5</sub>	B <sub>4</sub>	B <sub>3</sub>	B <sub>2</sub>	B <sub>1</sub>	B <sub>0</sub>	xx

### Description

Get the GPIO1 properties with respect to the LCD signal generators.

A[6:5] : Source 1 for GPIO1 when controlled by LCDC (POR = 00)

00 Generator 0  
 01 Generator 1  
 10 Generator 2  
 11 Generator 3

A[3:2] : Source 2 for GPIO1 when controlled by LCDC (POR = 00)

00 Generator 0  
 01 Generator 1  
 10 Generator 2  
 11 Generator 3

A[1:0] : Source 3 for GPIO1 when controlled by LCDC (POR = 00)

00 Generator 0  
 01 Generator 1  
 10 Generator 2  
 11 Generator 3

B[7:0] : ROP3 operation between source 1, 2 and 3 for GPIO1 (POR = 00000000)

Please refer to the ROP3 operation table

## 9.61 Set GPIO2 ROP

**Command** CCh  
**Parameters** 2

	D/C	D7	D6	D5	D4	D3	D2	D1	D0	Hex
Command	0	1	1	0	0	1	1	0	0	CC
Parameter 1	1	0	A <sub>6</sub>	A <sub>5</sub>	0	A <sub>3</sub>	A <sub>2</sub>	A <sub>1</sub>	A <sub>0</sub>	xx
Parameter 2	1	B <sub>7</sub>	B <sub>6</sub>	B <sub>5</sub>	B <sub>4</sub>	B <sub>3</sub>	B <sub>2</sub>	B <sub>1</sub>	B <sub>0</sub>	xx

### Description

Set the GPIO2 with respect to the LCD signal generators using ROP3 operation. No effect if the GPIO2 is configured as general GPIO.

A[6:5] : Source 1 for GPIO2 when controlled by LCDC (POR = 00)

00 Generator 0  
 01 Generator 1  
 10 Generator 2  
 11 Generator 3

A[3:2] : Source 2 for GPIO2 when controlled by LCDC (POR = 00)  
 00 Generator 0  
 01 Generator 1  
 10 Generator 2  
 11 Generator 3

A[1:0] : Source 3 for GPIO2 when controlled by LCDC (POR = 00)  
 00 Generator 0  
 01 Generator 1  
 10 Generator 2  
 11 Generator 3

B[7:0] : ROP3 operation between source 1, 2 and 3 for GPIO2 (POR = 00000000)  
 Please refer to the ROP3 operation table

## 9.62 Get GPIO2 ROP

**Command** CDh  
**Parameters** 2

	D/C	D7	D6	D5	D4	D3	D2	D1	D0	Hex
Command	0	1	1	0	0	1	1	0	1	CD
Parameter 1	1	0	A <sub>6</sub>	A <sub>5</sub>	0	A <sub>3</sub>	A <sub>2</sub>	A <sub>1</sub>	A <sub>0</sub>	xx
Parameter 2	1	B <sub>7</sub>	B <sub>6</sub>	B <sub>5</sub>	B <sub>4</sub>	B <sub>3</sub>	B <sub>2</sub>	B <sub>1</sub>	B <sub>0</sub>	xx

### Description

Get the GPIO2 properties with respect to the LCD signal generators.

A[6:5] : Source 1 for GPIO2 when controlled by LCDC (POR = 00)  
 00 Generator 0  
 01 Generator 1  
 10 Generator 2  
 11 Generator 3

A[3:2] : Source 2 for GPIO2 when controlled by LCDC (POR = 00)  
 00 Generator 0  
 01 Generator 1  
 10 Generator 2  
 11 Generator 3

A[1:0] : Source 3 for GPIO2 when controlled by LCDC (POR = 00)  
 00 Generator 0  
 01 Generator 1  
 10 Generator 2  
 11 Generator 3

B[7:0] : ROP3 operation between source 1, 2 and 3 for GPIO2 (POR = 00000000)  
 Please refer to the ROP3 operation table

### 9.63 Set GPIO3 ROP

**Command** CEh  
**Parameters** 2

	D/C	D7	D6	D5	D4	D3	D2	D1	D0	Hex
Command	0	1	1	0	0	1	1	1	0	CE
Parameter 1	1	0	A <sub>6</sub>	A <sub>5</sub>	0	A <sub>3</sub>	A <sub>2</sub>	A <sub>1</sub>	A <sub>0</sub>	xx
Parameter 2	1	B <sub>7</sub>	B <sub>6</sub>	B <sub>5</sub>	B <sub>4</sub>	B <sub>3</sub>	B <sub>2</sub>	B <sub>1</sub>	B <sub>0</sub>	xx

#### Description

Set the GPIO3 with respect to the LCD signal generators using ROP3 operation. No effect if the GPIO3 is configured as general GPIO.

A[6:5] : Source 1 for GPIO3 when controlled by LCDC (POR = 00)

- 00 Generator 0
- 01 Generator 1
- 10 Generator 2
- 11 Generator 3

A[3:2] : Source 2 for GPIO3 when controlled by LCDC (POR = 00)

- 00 Generator 0
- 01 Generator 1
- 10 Generator 2
- 11 Generator 3

A[1:0] : Source 3 for GPIO3 when controlled by LCDC (POR = 00)

- 00 Generator 0
- 01 Generator 1
- 10 Generator 2
- 11 Generator 3

B[7:0] : ROP3 operation between source 1, 2 and 3 for GPIO3 (POR = 00000000)

Please refer to the ROP3 operation table

### 9.64 Get GPIO3 ROP

**Command** CFh  
**Parameters** 2

	D/C	D7	D6	D5	D4	D3	D2	D1	D0	Hex
Command	0	1	1	0	0	1	1	1	1	CF
Parameter 1	1	0	A <sub>6</sub>	A <sub>5</sub>	0	A <sub>3</sub>	A <sub>2</sub>	A <sub>1</sub>	A <sub>0</sub>	xx
Parameter 2	1	B <sub>7</sub>	B <sub>6</sub>	B <sub>5</sub>	B <sub>4</sub>	B <sub>3</sub>	B <sub>2</sub>	B <sub>1</sub>	B <sub>0</sub>	xx

#### Description

Get the GPIO3 properties with respect to the LCD signal generators.

A[6:5] : Source 1 for GPIO3 when controlled by LCDC (POR = 00)

- 00 Generator 0
- 01 Generator 1
- 10 Generator 2
- 11 Generator 3

A[3:2] : Source 2 for GPIO3 when controlled by LCDC (POR = 00)  
 00 Generator 0  
 01 Generator 1  
 10 Generator 2  
 11 Generator 3

A[1:0] : Source 3 for GPIO3 when controlled by LCDC (POR = 00)  
 00 Generator 0  
 01 Generator 1  
 10 Generator 2  
 11 Generator 3

B[7:0] : ROP3 operation between source 1, 2 and 3 for GPIO3 (POR = 00000000)  
 Please refer to the ROP3 operation table

## 9.65 Set DBC Configuration

**Command** D0h  
**Parameters** 1

	D/C	D7	D6	D5	D4	D3	D2	D1	D0	Hex
Command	0	1	1	0	1	0	0	0	0	D0
Parameter 1	1	0	A <sub>6</sub>	A <sub>5</sub>	0	A <sub>3</sub>	A <sub>2</sub>	0	A <sub>0</sub>	xx

### Description

Set the Dynamic Backlight Control configuration.

A[6] : DBC Manual Brightness enable (POR = 1)  
 0 Enable  
 1 Disable

A[5] : Transition effect (POR = 0)  
 0 Transition effect disable  
 1 Transition effect enable

Transition effect is used to remove visible backlight flickering. If rapid brightness change is required, it is recommended to enable this bit.

A[3:2] : Energy saving selection for DBC (POR = 00)  
 00 DBC is disable  
 01 Conservative mode  
 10 Normal mode  
 11 Aggressive mode

A[0] : Master enable of DBC (POR = 0)  
 0 DBC disable  
 1 DBC enable

The hardware pin, PWM is the output signal from SSD1963 to the system backlight driver. So it should configure PWM module before enable DBC.

```

WRITE COMMAND "0xBE"
WRITE DATA "0x0E" (set PWM frequency)
WRITE DATA "0xFF" (dummy value if DBC is used)
WRITE DATA "0x09" (enable PWM controlled by DBC)
WRITE DATA "0xFF"
WRITE DATA "0x00"
WRITE DATA "0x00"

WRITE COMMAND "0xD4" (Define the threshold value)
WRITE DATA .....

WRITE COMMAND "0xD0"
WRITE DATA "0x0D" (Enable DBC with Aggressive mode)

```

## 9.66 Get DBC Configuration

**Command** D1h  
**Parameters** 1

	D/C	D7	D6	D5	D4	D3	D2	D1	D0	Hex
Command	0	1	1	0	1	0	0	0	1	D1
Parameter 1	1	0	A <sub>6</sub>	A <sub>5</sub>	0	A <sub>3</sub>	A <sub>2</sub>	1	A <sub>0</sub>	xx

### Description

Get the current dynamic back light configuration.

A[6] : DBC Manual Brightness enable (POR = 1)

0 Enable  
1 Disable

A[5] : Transition effect (POR = 0)

0 Transition effect disable  
1 Transition effect enable

A[3:2] : Energy saving selection for DBC (POR = 00)

00 DBC is disable  
01 Conservative mode  
10 Normal mode  
11 Aggressive mode

A[0] : Master enable DBC (POR = 0)

0 DBC disable  
1 DBC enable

## 9.67 Set DBC Threshold

**Command** D4h  
**Parameters** 9

	D/C	D7	D6	D5	D4	D3	D2	D1	D0	Hex
Command	0	1	1	0	1	0	1	0	0	D4
Parameter 1	1	0	0	0	0	0	0	0	DBC_TH1 <sub>16</sub>	xx
Parameter 2	1	DBC_TH1 <sub>15</sub>	DBC_TH1 <sub>14</sub>	DBC_TH1 <sub>13</sub>	DBC_TH1 <sub>12</sub>	DBC_TH1 <sub>11</sub>	DBC_TH1 <sub>10</sub>	DBC_TH1 <sub>9</sub>	DBC_TH1 <sub>8</sub>	xx
Parameter 3	1	DBC_TH1 <sub>7</sub>	DBC_TH1 <sub>6</sub>	DBC_TH1 <sub>5</sub>	DBC_TH1 <sub>4</sub>	DBC_TH1 <sub>3</sub>	DBC_TH1 <sub>2</sub>	DBC_TH1 <sub>1</sub>	DBC_TH1 <sub>0</sub>	xx
Parameter 4	1	0	0	0	0	0	0	0	DBC_TH2 <sub>16</sub>	xx
Parameter 5	1	DBC_TH2 <sub>15</sub>	DBC_TH2 <sub>14</sub>	DBC_TH2 <sub>13</sub>	DBC_TH2 <sub>12</sub>	DBC_TH2 <sub>11</sub>	DBC_TH2 <sub>10</sub>	DBC_TH2 <sub>9</sub>	DBC_TH2 <sub>8</sub>	xx
Parameter 6	1	DBC_TH2 <sub>7</sub>	DBC_TH2 <sub>6</sub>	DBC_TH2 <sub>5</sub>	DBC_TH2 <sub>4</sub>	DBC_TH2 <sub>3</sub>	DBC_TH2 <sub>2</sub>	DBC_TH2 <sub>1</sub>	DBC_TH2 <sub>0</sub>	xx
Parameter 7	1	0	0	0	0	0	0	0	DBC_TH3 <sub>16</sub>	xx
Parameter 8	1	DBC_TH3 <sub>15</sub>	DBC_TH3 <sub>14</sub>	DBC_TH3 <sub>13</sub>	DBC_TH3 <sub>12</sub>	DBC_TH3 <sub>11</sub>	DBC_TH3 <sub>10</sub>	DBC_TH3 <sub>9</sub>	DBC_TH3 <sub>8</sub>	xx
Parameter 9	1	DBC_TH3 <sub>7</sub>	DBC_TH3 <sub>6</sub>	DBC_TH3 <sub>5</sub>	DBC_TH3 <sub>4</sub>	DBC_TH3 <sub>3</sub>	DBC_TH3 <sub>2</sub>	DBC_TH3 <sub>1</sub>	DBC_TH3 <sub>0</sub>	xx

### Description

Set the threshold for each level of power saving.

DBC\_TH1[16] : High byte of the threshold setting for the Conservative mode of DBC. (POR = 0)

DBC\_TH1[15:8] : 2nd byte of the threshold setting for the Conservative mode of DBC. (POR = 00000000)

DBC\_TH1[7:0] : Low byte of the threshold setting for the Conservative mode of DBC. (POR = 00000000)

TH1 = display width \* display height \* 3 \* 0.1 / 16

DBC\_TH2[16] : High byte of the threshold setting for the Normal mode of DBC. (POR = 0)

DBC\_TH2[15:8] : 2nd byte of the threshold setting for the Normal mode of DBC. (POR = 00000000)

DBC\_TH2[7:0] : Low byte of the threshold setting for the Normal mode of DBC. (POR = 00000000)

TH2 = display width \* display height \* 3 \* 0.25 / 16

DBC\_TH3[16] : High byte of the threshold setting for the Aggressive mode of DBC. (POR = 0)

DBC\_TH3[15:8] : 2nd byte of the threshold setting for the Aggressive mode of DBC. (POR = 00000000)

DBC\_TH3[7:0] : Low byte of the threshold setting for the Aggressive mode of DBC. (POR = 00000000)

TH3 = display width \* display height \* 3 \* 0.6 / 16

## 9.68 Get DBC Threshold

**Command** D5h  
**Parameters** 9

	D/C	D7	D6	D5	D4	D3	D2	D1	D0	Hex
Command	0	1	1	0	1	0	1	0	1	D5
Parameter 1	1	0	0	0	0	0	0	0	DBC_TH1 <sub>16</sub>	xx
Parameter 2	1	DBC_TH1 <sub>15</sub>	DBC_TH1 <sub>14</sub>	DBC_TH1 <sub>13</sub>	DBC_TH1 <sub>12</sub>	DBC_TH1 <sub>11</sub>	DBC_TH1 <sub>10</sub>	DBC_TH1 <sub>9</sub>	DBC_TH1 <sub>8</sub>	xx
Parameter 3	1	DBC_TH1 <sub>7</sub>	DBC_TH1 <sub>6</sub>	DBC_TH1 <sub>5</sub>	DBC_TH1 <sub>4</sub>	DBC_TH1 <sub>3</sub>	DBC_TH1 <sub>2</sub>	DBC_TH1 <sub>1</sub>	DBC_TH1 <sub>0</sub>	xx
Parameter 4	1	0	0	0	0	0	0	0	DBC_TH2 <sub>16</sub>	xx
Parameter 5	1	DBC_TH2 <sub>15</sub>	DBC_TH2 <sub>14</sub>	DBC_TH2 <sub>13</sub>	DBC_TH2 <sub>12</sub>	DBC_TH2 <sub>11</sub>	DBC_TH2 <sub>10</sub>	DBC_TH2 <sub>9</sub>	DBC_TH2 <sub>8</sub>	xx
Parameter 6	1	DBC_TH2 <sub>7</sub>	DBC_TH2 <sub>6</sub>	DBC_TH2 <sub>5</sub>	DBC_TH2 <sub>4</sub>	DBC_TH2 <sub>3</sub>	DBC_TH2 <sub>2</sub>	DBC_TH2 <sub>1</sub>	DBC_TH2 <sub>0</sub>	xx
Parameter 7	1	0	0	0	0	0	0	0	DBC_TH3 <sub>16</sub>	xx
Parameter 8	1	DBC_TH3 <sub>15</sub>	DBC_TH3 <sub>14</sub>	DBC_TH3 <sub>13</sub>	DBC_TH3 <sub>12</sub>	DBC_TH3 <sub>11</sub>	DBC_TH3 <sub>10</sub>	DBC_TH3 <sub>9</sub>	DBC_TH3 <sub>8</sub>	xx
Parameter 9	1	DBC_TH3 <sub>7</sub>	DBC_TH3 <sub>6</sub>	DBC_TH3 <sub>5</sub>	DBC_TH3 <sub>4</sub>	DBC_TH3 <sub>3</sub>	DBC_TH3 <sub>2</sub>	DBC_TH3 <sub>1</sub>	DBC_TH3 <sub>0</sub>	xx

### Description

Get the threshold for each level of power saving.

DBC\_TH1[16] : High byte of the threshold setting for the Conservative mode of DBC. (POR = 0)  
 DBC\_TH1[15:8] : 2nd byte of the threshold setting for the Conservative mode of DBC. (POR = 00000000)  
 DBC\_TH1[7:0] : Low byte of the threshold setting for the Conservative mode of DBC. (POR = 00000000)

DBC\_TH2[16] : High byte of the threshold setting for the Normal mode of DBC. (POR = 0)  
 DBC\_TH2[15:8] : 2nd byte of the threshold setting for the Normal mode of DBC. (POR = 00000000)  
 DBC\_TH2[7:0] : Low byte of the threshold setting for the Normal mode of DBC. (POR = 00000000)

DBC\_TH3[16] : High byte of the threshold setting for the Aggressive mode of DBC. (POR = 0)  
 DBC\_TH3[15:8] : 2nd byte of the threshold setting for the Aggressive mode of DBC. (POR = 00000000)  
 DBC\_TH3[7:0] : Low byte of the threshold setting for the Aggressive mode of DBC. (POR = 00000000)

## 9.69 Set PLL

**Command** E0h  
**Parameters** 1

	D/C	D7	D6	D5	D4	D3	D2	D1	D0	Hex
Command	0	1	1	1	0	0	0	0	0	E0
Parameter 1	1	0	0	0	0	0	0	A <sub>1</sub>	A <sub>0</sub>	xx

### Description

Start the PLL. Before the start, the system was operated with the crystal oscillator or clock input.

A[1] : Lock PLL (POR = 0)  
 After PLL enabled for 100us, can start to lock PLL  
 0 Use reference clock as system clock  
 1 Use PLL output as system clock

A[0] : Enable PLL (POR = 0)  
 0 Disable PLL  
 1 Enable PLL

SSD1963 needed to switch to PLL output as system clock after PLL is locked. The following is the program sequence.

```
WRITE COMMAND "0xE0"
WRITE DATA "0x01"
Wait 100us to let the PLL stable
WRITE DATA "0x03"
```

\* Note : SSD1963 is operating under reference clock before PLL is locked, registers cannot be set faster than half of the reference clock frequency. For instance, SSD1963 with a 10MHz reference clock is not allowed to be programmed higher than 5M words/s.

## 9.70 Set PLL MN

**Command** E2h  
**Parameters** 3

	D/C	D7	D6	D5	D4	D3	D2	D1	D0	Hex
Command	0	1	1	1	0	0	0	1	0	E2
Parameter 1	1	N <sub>7</sub>	N <sub>6</sub>	N <sub>5</sub>	N <sub>4</sub>	N <sub>3</sub>	N <sub>2</sub>	N <sub>1</sub>	N <sub>0</sub>	xx
Parameter 2	1	0	0	0	0	M <sub>3</sub>	M <sub>2</sub>	M <sub>1</sub>	M <sub>0</sub>	xx
Parameter 3	1	0	0	0	0	0	C <sub>2</sub>	0	0	xx

### Description

Set the MN of PLL

N[7:0] : Multiplier (N) of PLL. (POR = 00101101)

M[3:0] : Divider (M) of PLL. (POR = 0011)

C[2] : Effectuate MN value (POR = 0)

- 0 Ignore the multiplier (N) and divider (M) values in A[7:0] and B[7:0]
- 1 Effectuate the multiplier and divider value

VCO = Reference input clock x N

PLL frequency = VCO / M

\* **Note : 250MHz < VCO < 800MHz**

For a 10MHz reference clock to obtain 115MHz PLL frequency, user cannot program N = 23 and M = 2. The closet setting in this situation is setting N=34 and M=3, where  $10 \times 34 / 3 = 113.33\text{MHz}$ .

```
WRITE COMMAND "0xE2"
WRITE DATA "0x21" (N=34)
WRITE DATA "0x02" (M=3)
WRITE DATA "0x54" (Dummy Byte)
```



## 9.71 Get PLL MN

**Command** E3h  
**Parameters** 3

	D/C	D7	D6	D5	D4	D3	D2	D1	D0	Hex
Command	0	1	1	1	0	0	0	1	1	E3
Parameter 1	1	N <sub>7</sub>	N <sub>6</sub>	N <sub>5</sub>	N <sub>4</sub>	N <sub>3</sub>	N <sub>2</sub>	N <sub>1</sub>	N <sub>0</sub>	xx
Parameter 2	1	0	0	0	0	M <sub>3</sub>	M <sub>2</sub>	M <sub>1</sub>	M <sub>0</sub>	xx
Parameter 3	1	0	0	0	0	0	C <sub>2</sub>	0	0	xx

### Description

Get the MN setting of PLL

N[7:0] : Multiplier (N) of PLL. (POR = 00101101)

M[3:0] : Divider (M) of PLL. (POR = 0011)

C[2] : Effectuate MN value (POR = 0)

0 Ignore the multiplier (N) and divider (M) values in A[7:0] and B[7:0]

1 Effectuate the multiplier and divider value

## 9.72 Get PLL Status

**Command** E4h  
**Parameters** 1

	D/C	D7	D6	D5	D4	D3	D2	D1	D0	Hex
Command	0	1	1	1	0	0	1	0	0	E4
Parameter 1	1	0	0	0	0	0	A <sub>2</sub>	0	0	xx

### Description

Get the PLL status

A[2] : PLL Lock

0 Not locked

1 Locked

## 9.73 Set Deep Sleep

**Command** E5h  
**Parameters** None

	D/C	D7	D6	D5	D4	D3	D2	D1	D0	Hex
Command	0	1	1	1	0	0	1	0	1	E5

### Description

Set deep sleep mode. PLL would be stopped.

It needs to issue 2 dummy read to exit Deep Sleep mode.

## 9.74 Set LSHIFT Frequency

**Command** E6h  
**Parameters** 3

	D/C	D7	D6	D5	D4	D3	D2	D1	D0	Hex
Command	0	1	1	1	0	0	1	1	0	E6
Parameter 1	1	0	0	0	0	LCDC_FPR <sub>19</sub>	LCDC_FPR <sub>18</sub>	LCDC_FPR <sub>17</sub>	LCDC_FPR <sub>16</sub>	xx
Parameter 2	1	LCDC_FPR <sub>15</sub>	LCDC_FPR <sub>14</sub>	LCDC_FPR <sub>13</sub>	LCDC_FPR <sub>12</sub>	LCDC_FPR <sub>11</sub>	LCDC_FPR <sub>10</sub>	LCDC_FPR <sub>9</sub>	LCDC_FPR <sub>8</sub>	xx
Parameter 3	1	LCDC_FPR <sub>7</sub>	LCDC_FPR <sub>6</sub>	LCDC_FPR <sub>5</sub>	LCDC_FPR <sub>4</sub>	LCDC_FPR <sub>3</sub>	LCDC_FPR <sub>2</sub>	LCDC_FPR <sub>1</sub>	LCDC_FPR <sub>0</sub>	xx

### Description

Set the LSHIFT (pixel clock) frequency

LCDC\_FPR[19:16] : The highest 4 bits for the pixel clock frequency settings. (POR = 0111)

LCDC\_FPR[15:8] : The higher byte for the pixel clock frequency settings. (POR = 11111111)

LCDC\_FPR[7:0] : The low byte for the pixel clock frequency settings. (POR = 11111111)

Configure the pixel clock to PLL freq x ((LCDC\_FPR + 1) / 2<sup>20</sup>)

To obtain PCLK = 5.3MHz with PLL Frequency = 120MHz,

$$5.3\text{MHz} = 120\text{MHz} * \text{LCDC\_FPR} / 2^{20}$$

$$\text{LCDC\_FPR} = 46312$$

WRITE COMMAND "0xE6"

WRITE DATA "0x00" (LCDC\_FPR = 46312)

WRITE DATA "0xB4"

WRITE DATA "0xE7"

## 9.75 Get LSHIFT Frequency

**Command** E7h  
**Parameters** 3

	D/C	D7	D6	D5	D4	D3	D2	D1	D0	Hex
Command	0	1	1	1	0	0	1	1	1	E7
Parameter 1	1	0	0	0	0	LCDC_FPR <sub>19</sub>	LCDC_FPR <sub>18</sub>	LCDC_FPR <sub>17</sub>	LCDC_FPR <sub>16</sub>	xx
Parameter 2	1	LCDC_FPR <sub>15</sub>	LCDC_FPR <sub>14</sub>	LCDC_FPR <sub>13</sub>	LCDC_FPR <sub>12</sub>	LCDC_FPR <sub>11</sub>	LCDC_FPR <sub>10</sub>	LCDC_FPR <sub>9</sub>	LCDC_FPR <sub>8</sub>	xx
Parameter 3	1	LCDC_FPR <sub>7</sub>	LCDC_FPR <sub>6</sub>	LCDC_FPR <sub>5</sub>	LCDC_FPR <sub>4</sub>	LCDC_FPR <sub>3</sub>	LCDC_FPR <sub>2</sub>	LCDC_FPR <sub>1</sub>	LCDC_FPR <sub>0</sub>	xx

### Description

Get the current LSHIFT (pixel clock) frequency setting

LCDC\_FPR[19:16] : The highest 4 bits for the pixel clock frequency settings. (POR = 0111)

LCDC\_FPR[15:8] : The higher byte for the pixel clock frequency settings. (POR = 11111111)

LCDC\_FPR[7:0] : The low byte for the pixel clock frequency settings. (POR = 11111111)

## 9.76 Set Pixel Data Interface

**Command** F0h  
**Parameters** 1

	D/C	D7	D6	D5	D4	D3	D2	D1	D0	Hex
Command	0	1	1	1	1	0	0	0	0	F0
Parameter 1	1	0	0	0	0	0	A <sub>2</sub>	A <sub>1</sub>	A <sub>0</sub>	xx

### Description

Set the pixel data format to 8-bit / 9-bit / 12-bit / 16-bit / 16-bit(565) / 18-bit / 24-bit in the parallel host processor interface

A[2:0] : Pixel Data Interface Format (POR = 101)

000 8-bit  
 001 12-bit  
 010 16-bit packed  
 011 16-bit (565 format)  
 100 18-bit  
 101 24-bit  
 110 9-bit  
 Others Reserved

## 9.77 Get Pixel Data Interface

**Command** F1h  
**Parameters** 1

	D/C	D7	D6	D5	D4	D3	D2	D1	D0	Hex
Command	0	1	1	1	1	0	0	0	1	F1
Parameter 1	1	0	0	0	0	0	A <sub>2</sub>	A <sub>1</sub>	A <sub>0</sub>	xx

### Description

Get the current pixel data format settings in the parallel host processor interface.

A[2:0] : Pixel Data Interface Format (POR = 101)

000 8-bit  
 001 12-bit  
 010 16-bit packed  
 011 16-bit (565 format)  
 100 18-bit  
 101 24-bit  
 110 9-bit  
 Others Reserved

## 10 MAXIMUM RATINGS

Table 10-1: Maximum Ratings (Voltage Referenced to V<sub>SS</sub>)

Symbol	Parameter	Value	Unit
V <sub>DDD</sub>	Digital Core power supply	-0.5 to 1.8	V
V <sub>DDPLL</sub>	PLL power supply	-0.5 to 1.8	V
V <sub>DDLCD</sub>	LCD Interface power supply	-0.5 to 4.6	V
V <sub>DDIO</sub>	I/O power supply	-0.5 to 4.6	V
V <sub>IN</sub>	Input Voltage	-0.5 to 4.6	V
V <sub>OUT</sub>	Output Voltage	-0.5 to 4.6	V
T <sub>SOL</sub>	Solder Temperature / Time	225 for 40 sec max at solder ball	°C
T <sub>STG</sub>	Storage temperature	-45 to 125	°C

Maximum ratings are those values beyond which damages to the device may occur. Functional operation should be restricted to the limits in the Electrical Characteristics tables or Pin Description section

This device contains circuitry to protect the inputs against damage due to high static voltages or electric fields; however, it is advised that normal precautions be taken to avoid application of any voltage higher than maximum rated voltages to this high impedance circuit. For proper operation it is recommended that V<sub>IN</sub> and V<sub>OUT</sub> be constrained to the range V<sub>SS</sub> < (V<sub>IN</sub> or V<sub>OUT</sub>) < V<sub>DDIO</sub>. Reliability of operation is enhanced if unused input is connected to an appropriate logic voltage level (e.g., either V<sub>SS</sub> or V<sub>DDIO</sub>). Unused outputs must be left open. This device may be light sensitive. Caution should be taken to avoid exposure of this device to any light source during normal operation. This device is not radiation protected.

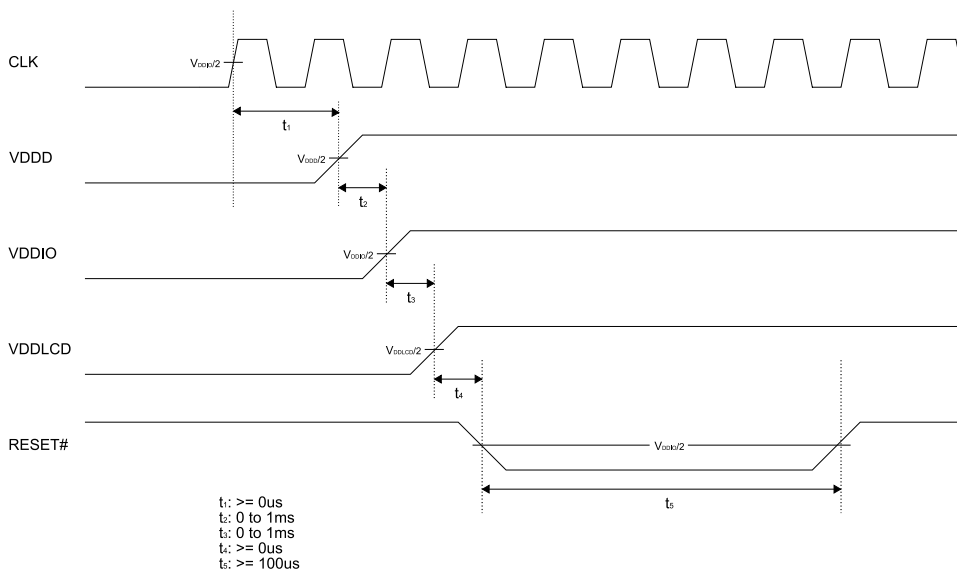
## 11 RECOMMENDED OPERATING CONDITIONS

Table 11-1: Recommended Operating Condition

Symbol	Parameter	Min	Typ	Max	Unit
V <sub>DDD</sub>	Digital Core power supply	1.08	1.2	1.32	V
V <sub>DDPLL</sub>	PLL power supply	1.08	1.2	1.32	V
V <sub>DDLCD</sub>	LCD Interface power supply	1.65	3.3	3.6	V
V <sub>DDIO</sub>	I/O power supply	1.65	3.3	3.6	V
T <sub>A</sub>	Operating temperature	-30	25	85	°C

### 11.1 Power-up sequence

Figure 11-1: Power-up Sequence



#### Note

Clock reference is only applicable when CLK is used.

## 12 DC CHARACTERISTICS

### Conditions:

Voltage referenced to  $V_{SS}$   
 $V_{DDD}, V_{DDPLL} = 1.2V$   
 $V_{DDIO}, V_{DDLCD} = 3.3V$   
 $T_A = 25^{\circ}C$

Table 12-1 : DC Characteristics

Symbol	Parameter	Test Condition	Min	Typ	Max	Unit
PSTY	Quiescent Power			300		uW
IIZ	Input leakage current		-1		1	uA
IOZ	Output leakage current		-1		1	uA
VOH	Output high voltage		$0.8V_{DDIO}$			V
VOL	Output low voltage				$0.2V_{DDIO}$	V
VIH	Input high voltage		$0.8V_{DDIO}$		$V_{DDIO} + 0.5$	V
VIL	Input low voltage				$0.2V_{DDIO}$	V

## 13 AC CHARACTERISTICS

### Conditions:

Voltage referenced to  $V_{SS}$   
 $V_{DDD}, V_{DDPLL} = 1.2V$   
 $V_{DDIO}, V_{DDLCD} = 3.3V$   
 $T_A = 25^{\circ}C$   
 $C_L = 50pF$  (Bus/CPU Interface)  
 $C_L = 0pF$  (LCD Panel Interface)

### 13.1 Clock Timing

Table 13-1 : Clock Input Requirements for CLK (PLL-bypass)

Symbol	Parameter	Min	Max	Units
$F_{CLK}$	Input Clock Frequency (CLK)		120	MHz
$T_{CLK}$	Input Clock period (CLK)	$1/f_{CLK}$		ns

Table 13-2 : Clock Input Requirements for CLK (Using PLL)

Symbol	Parameter	Min	Max	Units
$F_{CLK}$	Input Clock Frequency (CLK)	2.5	50	MHz
$T_{CLK}$	Input Clock period (CLK)	$1/f_{CLK}$		ns

Table 13-3 : Clock Input Requirements for crystal oscillator XTAL (Using PLL)

Symbol	Parameter	Min	Max	Units
$F_{XTAL}$	Input Clock Frequency	2.5	10	MHz
$T_{XTAL}$	Input Clock period	$1/f_{XTAL}$		ns

## 13.2 MCU Interface Timing

### 13.2.1 6800 Mode

Table 13-4: 6800 Mode Timing

Symbol	Parameter	Min	Typ	Max	Unit
$t_{cyc}$	Reference Clock Cycle Time	9	-	-	ns
$t_{pwCSL}$	Pulse width CS# or E low	1	-	-	$t_{cyc}$
$t_{pwCSH}$	Pulse width CS# or E high	1	-	-	$t_{cyc}$
$t_{FDRD}$	First Data Read Delay	5	-	-	$t_{cyc}$
$t_{AS}$	Address Setup Time	1	-	-	ns
$t_{AH}$	Address Hold Time	1	-	-	ns
$t_{DSW}$	Data Setup Time	4	-	-	ns
$t_{DHW}$	Data Hold Time	1	-	-	ns
$t_{DSR}$	Data Access Time	-	-	5	ns
$t_{DHR}$	Output Hold time	1	-	-	ns

Figure 13-1: 6800 Mode Timing Diagram (Use CS# as Clock)

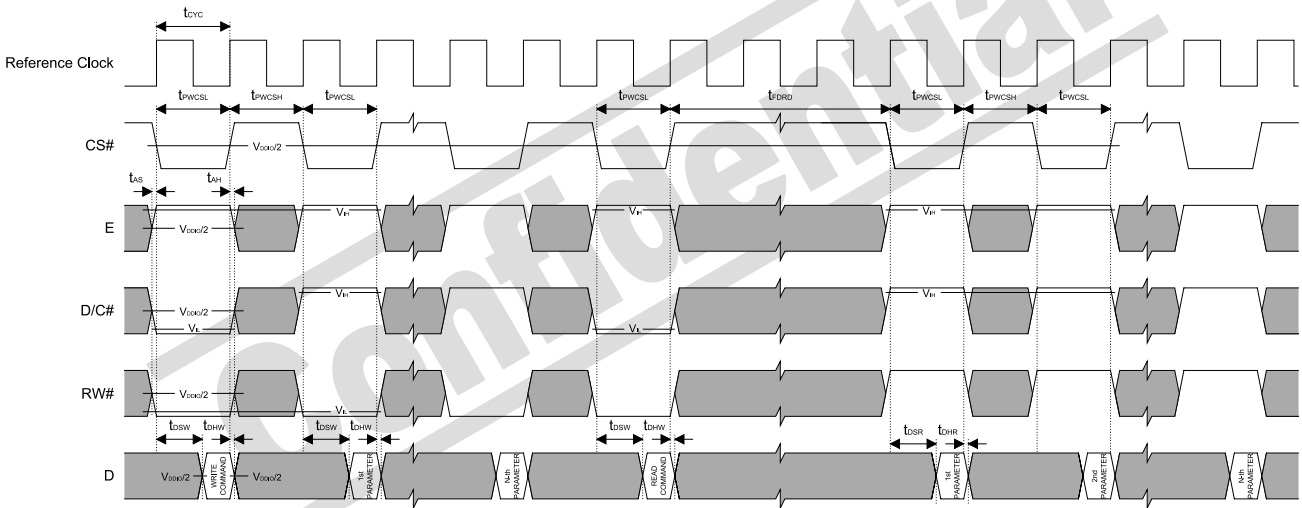
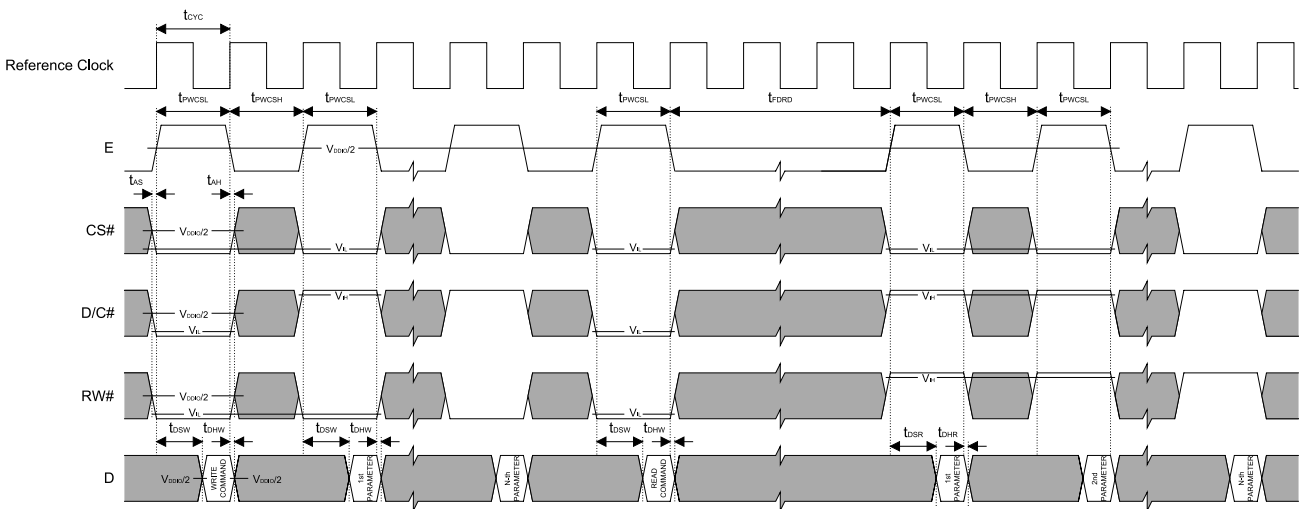


Figure 13-2: 6800 Mode Timing Diagram (Use E as Clock)

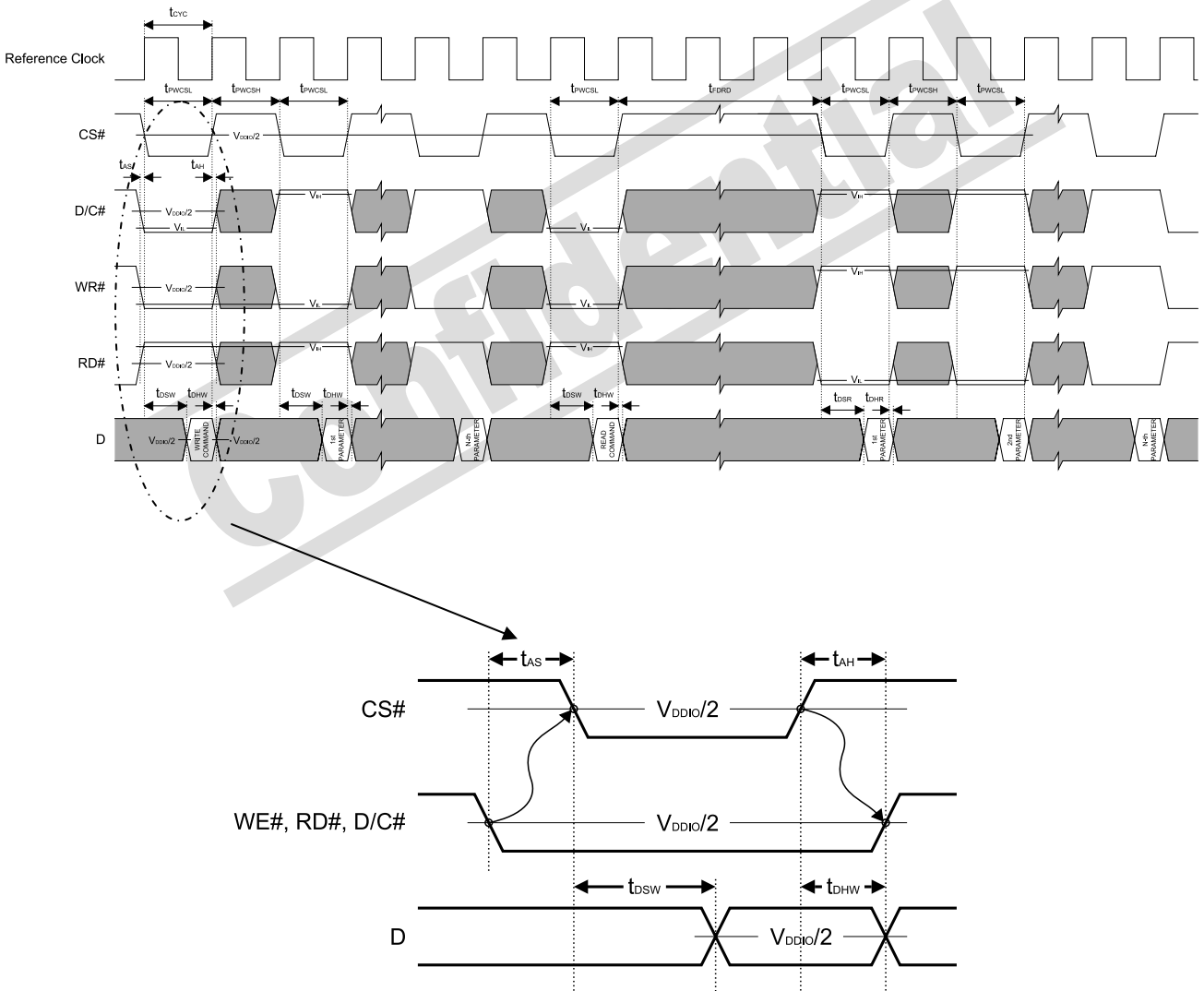


### 13.2.2 8080 Mode Write Cycle

Table 13-5: 8080 Mode Timing

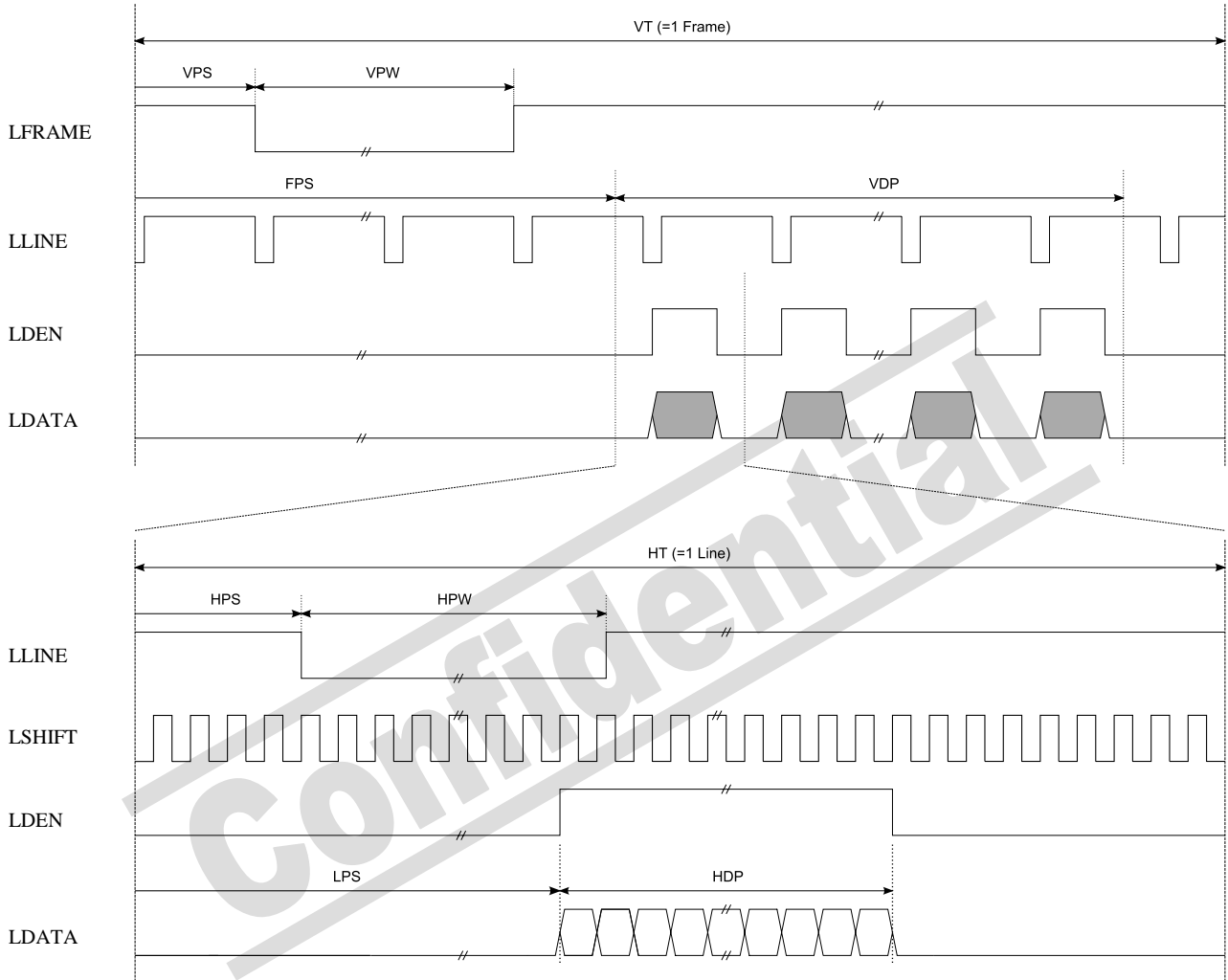
Symbol	Parameter	Min	Typ	Max	Unit
$t_{cyc}$	Reference Clock Cycle Time	9	-	-	ns
$t_{pwCSL}$	Pulse width CS# low	1	-	-	$t_{cyc}$
$t_{pwCSH}$	Pulse width CS# high	1	-	-	$t_{cyc}$
$t_{FDRD}$	First Read Data Delay	5	-	-	$t_{cyc}$
$t_{AS}$	Address Setup Time	1	-	-	ns
$t_{AH}$	Address Hold Time	1	-	-	ns
$t_{DSW}$	Data Setup Time	4	-	-	ns
$t_{DHW}$	Data Hold Time	1	-	-	ns
$t_{DSR}$	Data Access Time	-	-	5	ns
$t_{DHR}$	Output Hold time	1	-	-	ns

Figure 13-3: 8080 Mode Timing Diagram



### 13.3 LCD Interface Timing

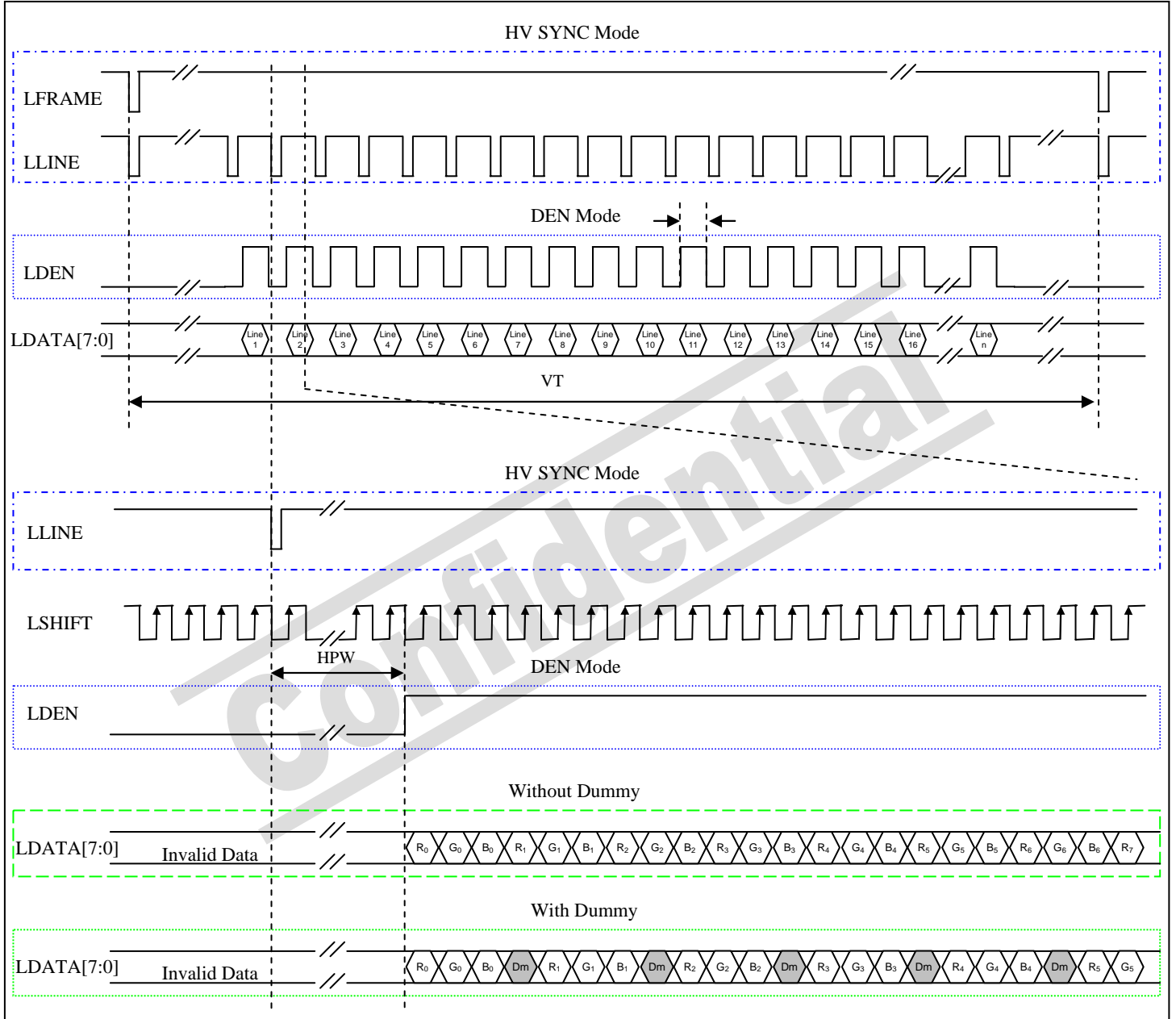
Figure 13-4: Generic TFT Panel Timing





### 13.4 8-bit Serial Interface

Figure 13-5: 8-bit Serial Interface Timing



## 14 APPLICATION EXAMPLE

Figure 14-1 : Application circuit for SSD1963 (With Direct clock input)

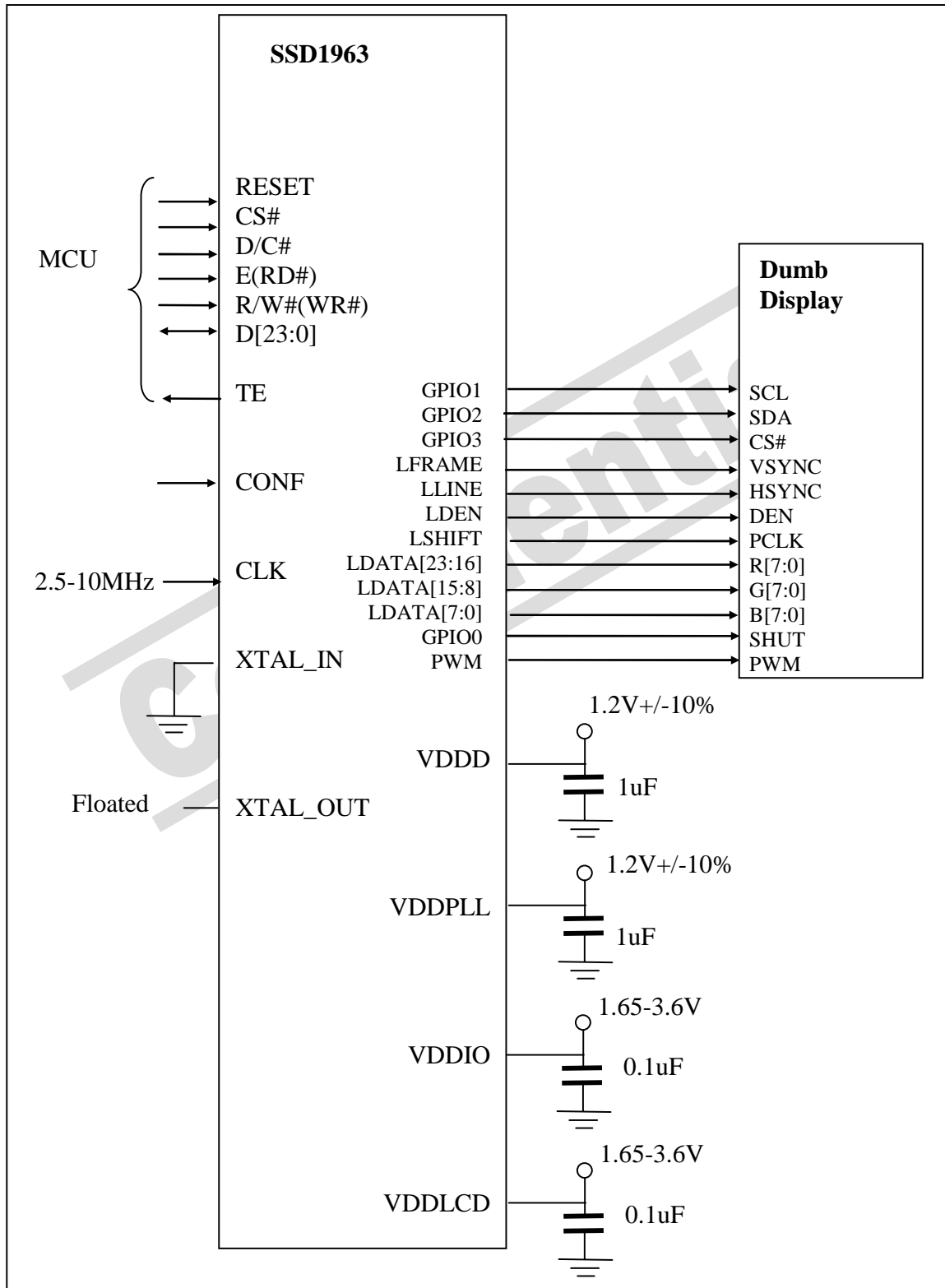
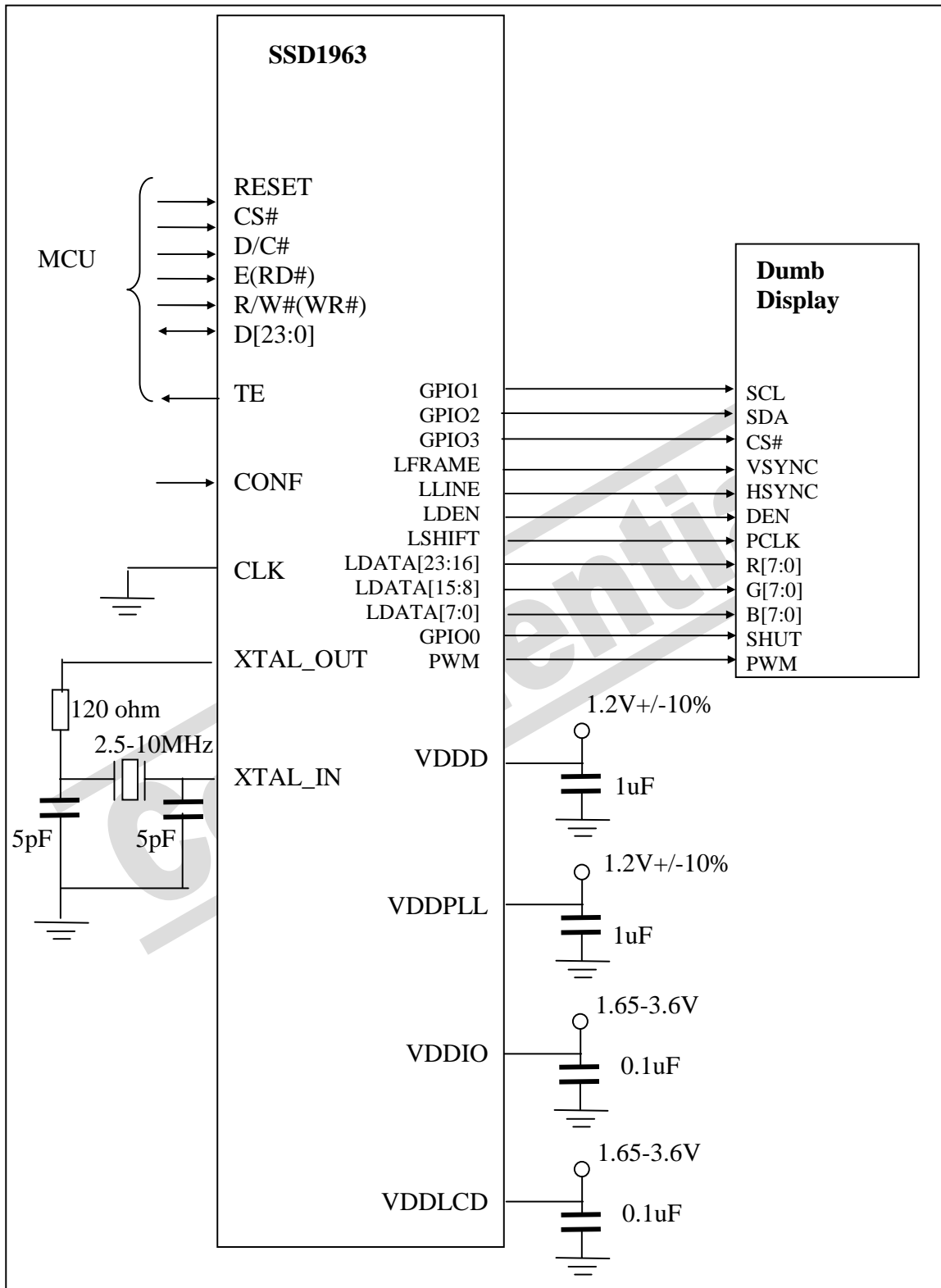
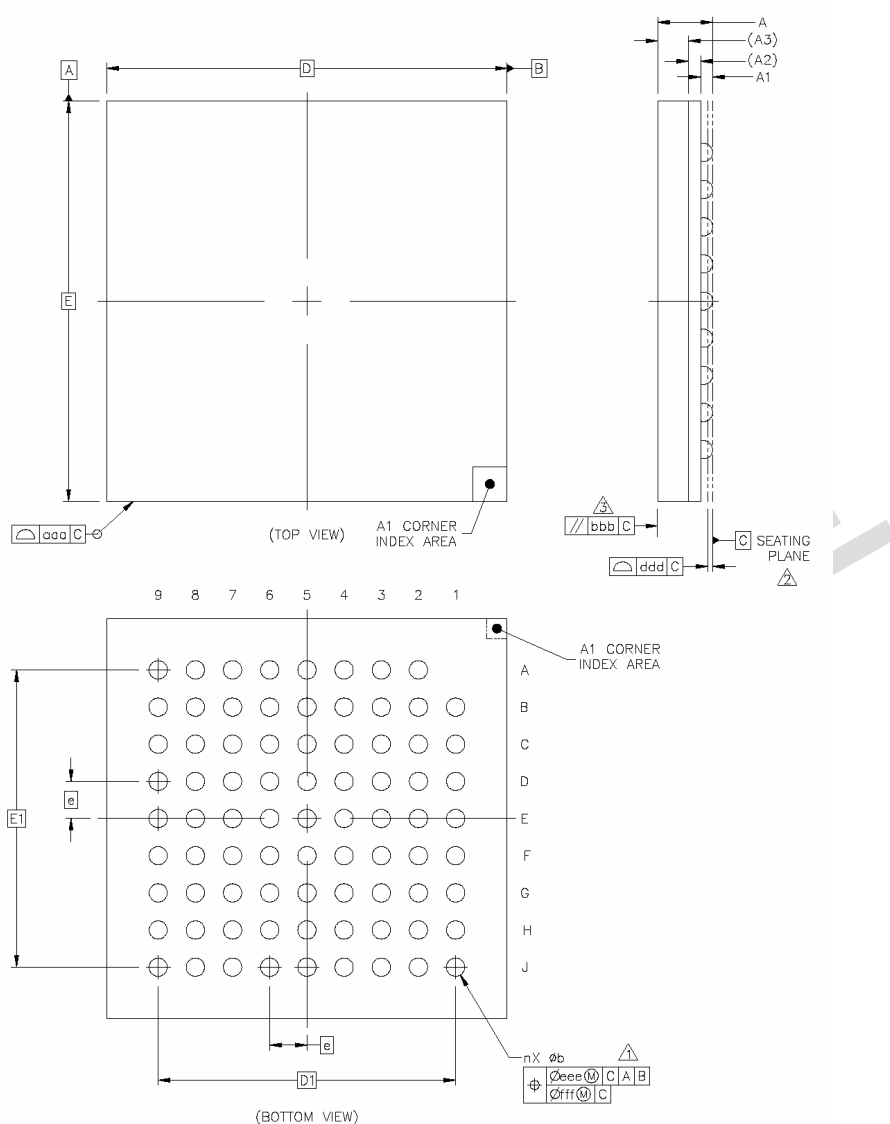


Figure 14-2 : Application circuit for SSD1963 (With crystal oscillator input)



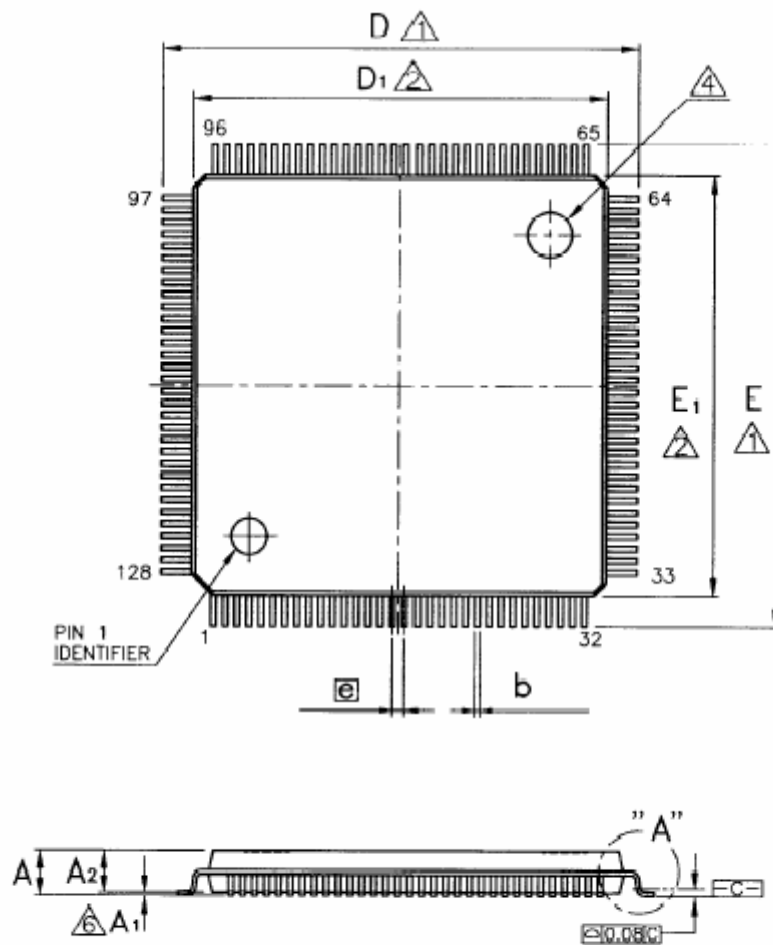
## 15 PACKAGE INFORMATION

### 15.1 Package Mechanical Drawing for 80 pins TFBGA



Dimension in mm			
Symbol	Min	Typical	Max
A	--	---	1.1
A1	0.16	---	0.26
A2	---	0.21	---
A3	---	0.54	---
b	0.27	---	0.37
D	---	7.00 BSC	---
E	---	7.00 BSC	---
e	---	0.65 BSC	---
D1	---	5.2 BSC	---
E1	---	5.2 BSC	---
aaa	---	0.1	---
bbb	---	0.2	---
ddd	---	0.08	---
eee	---	0.15	---
fff	---	0.08	---


## 15.2 Package Mechanical Drawing for 128 pins LQFP



Symbol	Dimension in mm		
	Min	Nom	Max
A			1.60
A1	0.05		
A2		1.40	
D		16.00	
D1		14.00	
E		16.00	
E1		14.00	
e		0.40 BSC	
b		0.18	

**Confidential**

Solomon Systech reserves the right to make changes without notice to any products herein. Solomon Systech makes no warranty, representation or guarantee regarding the suitability of its products for any particular purpose, nor does Solomon Systech assume any liability arising out of the application or use of any product or circuit, and specifically disclaims any, and all, liability, including without limitation consequential or incidental damages. "Typical" parameters can and do vary in different applications. All operating parameters, including "Typical" must be validated for each customer application by the customer's technical experts. Solomon Systech does not convey any license under its patent rights nor the rights of others. Solomon Systech products are not designed, intended, or authorized for use as components in systems intended for surgical implant into the body, or other applications intended to support or sustain life, or for any other application in which the failure of the Solomon Systech product could create a situation where personal injury or death may occur. Should Buyer purchase or use Solomon Systech products for any such unintended or unauthorized application, Buyer shall indemnify and hold Solomon Systech and its offices, employees, subsidiaries, affiliates, and distributors harmless against all claims, costs, damages, and expenses, and reasonable attorney fees arising out of, directly or indirectly, any claim of personal injury or death associated with such unintended or unauthorized use, even if such claim alleges that Solomon Systech was negligent regarding the design or manufacture of the part.

All Solomon Systech Products complied with six (6) hazardous substances limitation requirement per European Union (EU) "Restriction of Hazardous Substance (RoHS) Directive (2002/95/EC)" and China standard "电子信息产品污染控制标识要求 (SJ/T11364-2006)" with control Marking Symbol . Hazardous Substances test report is available upon requested.

<http://www.solomon-systech.com>